

Chanan

CHANGAN ELECTRIC

>>C series Industrial Controls

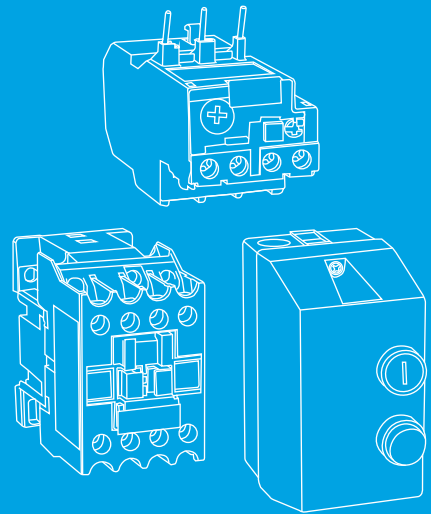

CHANGAN GROUP CO.,LTD.

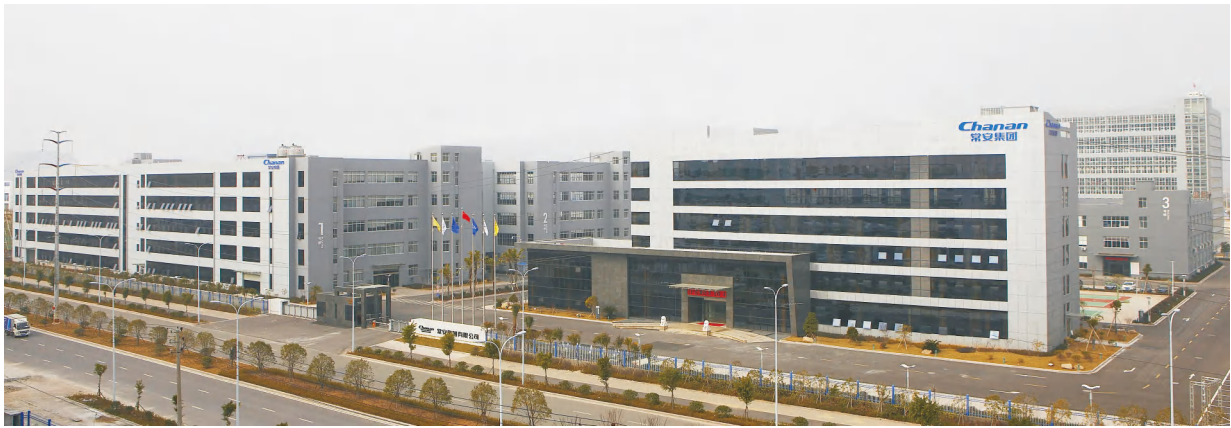

Yanpan factory

• Brief Introduction

Established in 1987, CHANGAN GROUP CO., LTD. has been acknowledged as one of the most respected nation-wide manufacturers and exporters of low-voltage electrical apparatus in China.

Comprising more than 62 factories with over 2500 employees and the whole corporation occupies 82000m² ground during past 27 years. We manufacture and export varieties of low voltage electrical appliance including all kinds of CIRCUIT BREAKER, CONTACTOR, RELAY, SWITCH, SOLAR INVERTER etc.

All of our production procedures strictly follow ISO9001, ISO14001 and ISO18001, most of our products are certified such as SEMKO, TUV, CB and CE which can prove our guarantee quality and our products also have been chosen as "CHINESE FAMOUS BRAND PRODUCT".

We not only make efforts in developing our own products with "Chanan" brand but also provide OEM services. Hope to establish good business relationships with your esteemed company in near future.



Liushi factory



Work shop

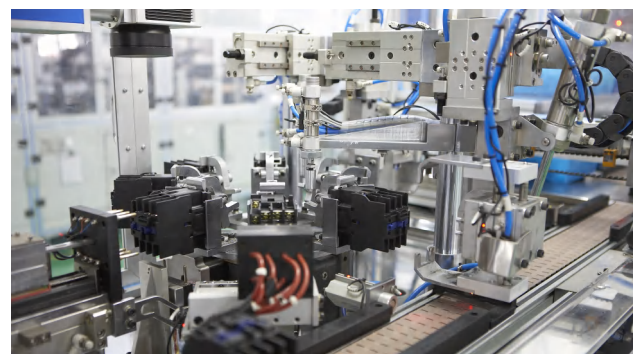

Automatic testing unit



CONTENTS

CC1 Contactor 9~95A	01-04
CC1 Contactor 115~800A	05-07
CJ19 Capacitor Switching Contactor	08-09
CC1 Mini Contactor 6~12A	10-11
CR2 Thermal Overload Relay	12-16
Contactor Accessories	17-18
CQ1 DOL Electromagnetic Starter	19-20
CQ2 DOL Electromagnetic Starter	21-22
CS2 Motor Protection Circuit Breaker	23-25
AD22 LED Indicator(Φ22mm)	26-27
AD22 LED Indicator With Voltage Meter(Φ22mm)	28-28
CB2 Pushbutton Switch(Φ22mm)	29-36
CB4 Pushbutton Switch(Φ22mm)	37-40
CAL Control Box	41-42
LW26 Rotary Switch	43-50
LW30 Isolation Switch	51-54
LW30 Isolation Switch PV DC Type	55-57



CC1-0910Z



CC1-2510Z



CC1-3210

1. Description

- Application: remote making & breaking circuits; protect circuit from over-load when assembling with thermal over-load relay; frequent start-up and control of AC contactor;
- Electric value: AC50/60Hz, 690V, up to 95A;
- Utilization category: AC-3, AC-4;
- Altitude: ≤2000m;
- Ambient temperature: -5°C~+40°C;
- Mounting category: III;
- Mounting conditions: inclination between the mounting plane and the vertical plane should not exceed ±5° ;
- Standard: IEC/EN 60947-4-1. IEC/EN 60947-5-1.

● Control Coil Voltage(AC Coil Operation)

Volts(VAC)	24	36	42	48	110	127	220	230	240	380	415	440	480	500	600
50Hz	B5	C5	D5	E5	F5	G5	M5	P5	U5	Q5	N5	R5	-	S5	Y5
60Hz	B6	-	D6	E6	F6	G6	M6	-	U6	Q6	-	R6	T6	-	-
50/60Hz	B7	-	D7	E7	F7	-	M7	P7	-	Q7	N7	R7	-	-	-

● Control Coil Voltage(DC Coil Operation)

Volts(VDC)	12	24	36	48	110	220
Code	JD	BD	CD	ED	FD	MD

2. Type Designation

C C 1-□ □ □ □ □

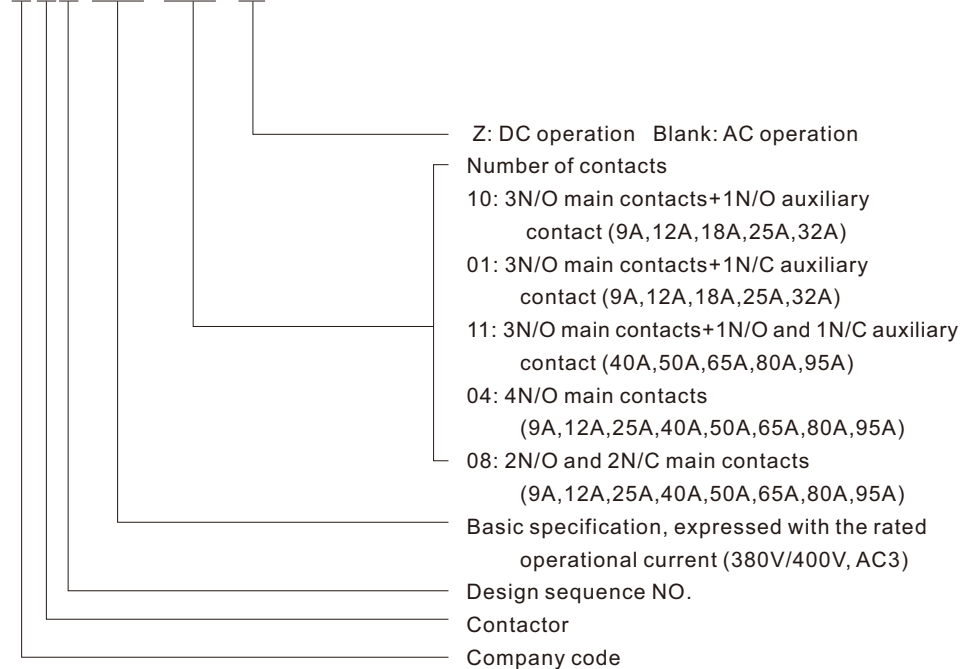

3. Technical Specification

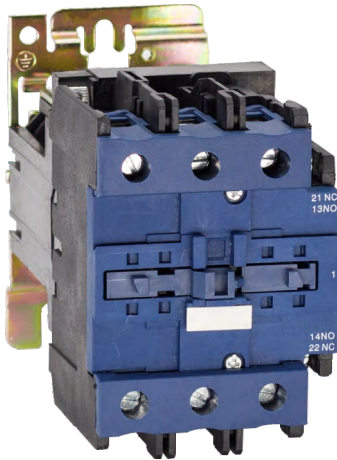

CC1-6511Z

Standard	IEC/EN60947-4-1 IEC/EN60947-5-1					
	Model No.	CC1-09	CC1-12	CC1-18	CC1-25	CC1-32
Rated Conventional Heating Current	Ith (A)	20	20	32	40	50
Rated Voltage Ui(V)	Ui(V)	690	690	690	690	690
Rated Operation Current Ue=380/415V	AC-3 Ie(A)	9	12	18	25	32
	AC-4 Ie(A)	3.5	5	7.7	8.5	12
Power Controlled 3ph cage Motor AC-3	220/240V KW	2.2	3	4	5.5	7.5
	380/415V KW	4	5.5	7.5	11	15
	660/690V KW	5.5	7.5	10	15	18.5
Electrical life(x10 ³ operations)	AC-3	1000	1000	1000	1000	800
	AC-4	200	200	200	200	200
Mechanical life(x10 ⁶ operations)		10	10	10	10	8
Matched Fuse	Size	RT16-00	RT16-00	RT16-00	RT16-00	RT16-00
	A	20	20	32	40	50
Main circuit		3P or 4P				
Auxiliary circuit Cat.:AC-15,Ue=415V Ie=0.95A Ith=10A		1NO or 1NC				



CC1-9511

Standard	IEC/EN60947-4-1 IEC/EN60947-5-1					
	Model No.	CC1-40	CC1-50	CC1-65	CC1-80	CC1-95
Rated Conventional Heating Current	Ith (A)	60	80	80	100	125
Rated Voltage Ui(V)	Ui(V)	690	690	690	690	690
Rated Operation Current Ue=380/415V	AC-3 Ie(A)	40	50	65	80	95
	AC-4 Ie(A)	18.5	24	28	37	44
Power Controlled 3ph cage Motor AC-3	220/240V KW	11	15	18.5	22	25
	380/415V KW	18.5	22	30	37	45
	660/690V KW	30	33	37	45	45
Electrical life(x10 ³ operations)	AC-3	800	600	600	600	600
	AC-4	150	150	150	100	100
Mechanical life(x10 ⁶ operations)		8	8	8	6	6
Matched Fuse	Size	RT16-00	RT16-00	RT16-00	RT16-00	RT16-00
	A	63	80	80	100	125
Main circuit		3P or 4P				
Auxiliary circuit Cat.:AC-15,Ue=415V Ie=0.95A Ith=10A		1NO+1NC				

4. Technical Information

4.1 Terminal connection

Model	Number of piece	Cabling cross section(Cu)			screw size	Tightening torque(N.m)
		Flexible cable with cold-pressed socket(mm ²)	Flexible cable without cold-pressed socket(mm ²)	Inflexible cable(mm ²)		
CC1-09	1~2	2.5	4	4	M3.5	0.8
CC1-12	1~2	2.5	4	4	M3.5	0.8
CC1-18	1~2	4	6	6	M3.5	0.8
CC1-25	1	4	10	6	M4	1.2
	2	4	6	6	M4	1.2
CC1-32	1	4	10	6	M4	1.2
	2	4	6	6	M4	1.2
CC1-40	1	10	16	10	M4	3.5
	2	10	10	10	M8	3.5
CC1-50	1	16	25	25	M8	3.5
	2	16	16	-	M8	3.5
CC1-65	1	16	25	25	M8	3.5
	2	16	16	-	M8	3.5
CC1-80	1	50	50	50	M8	3.5
	2	25	35	-	M10	4.0
CC1-95	1	50	50	50	M10	4.0
	2	25	35	-	M10	4.0

4.2 Curve

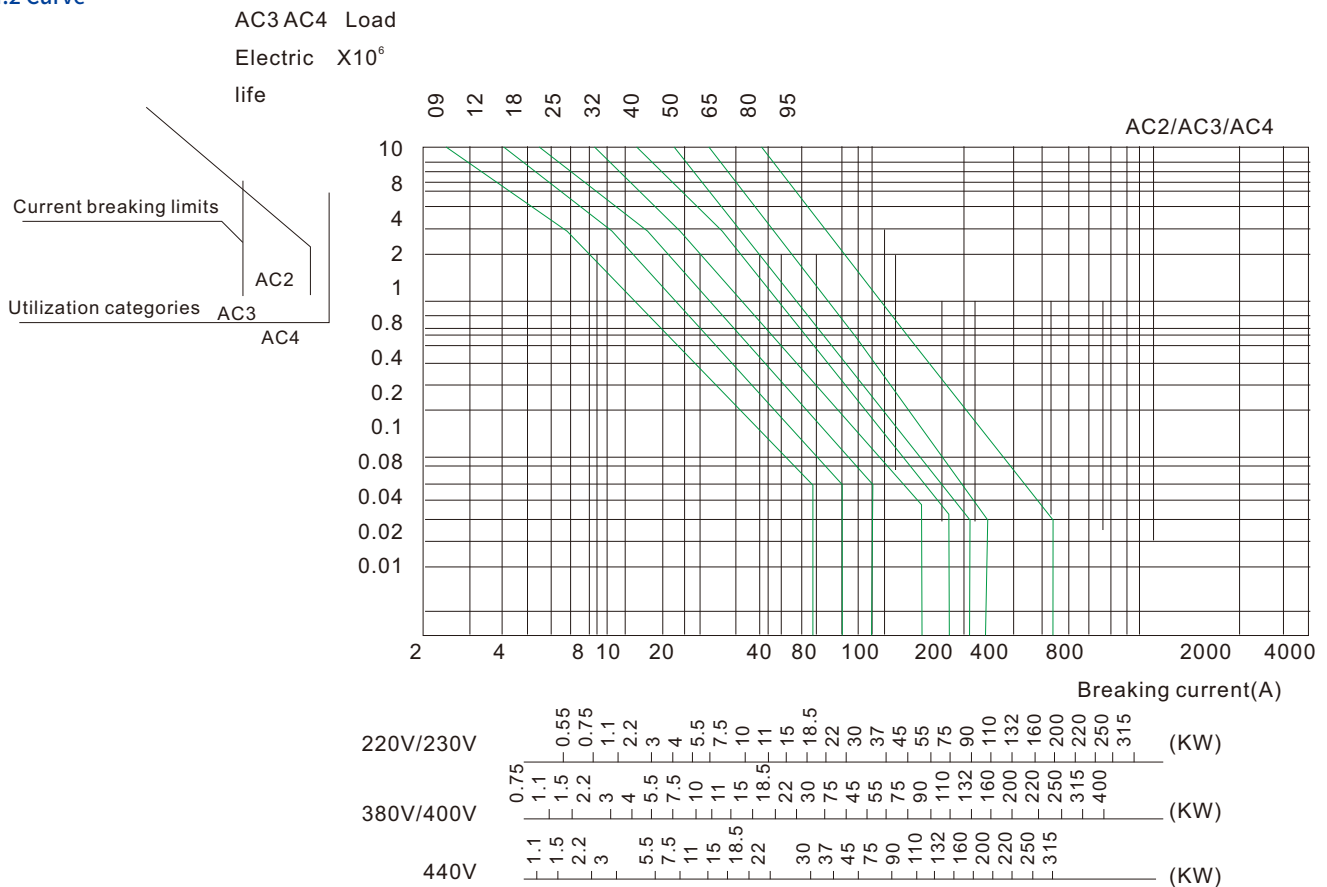

5. Overall and Mounting Dimension (mm)

CC1-09~32

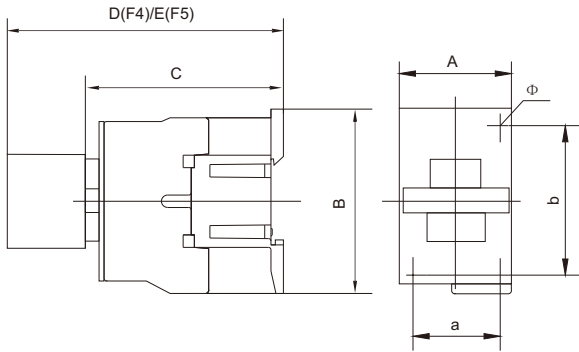

CC1-40~95

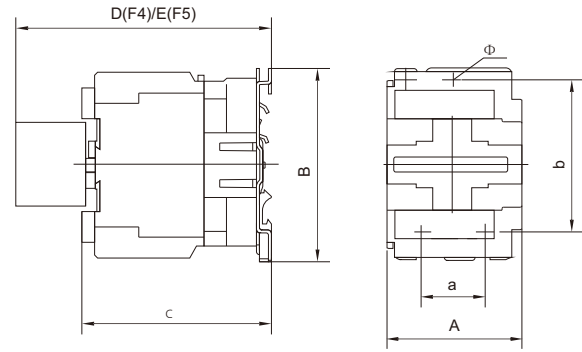

CC1-09Z~32Z

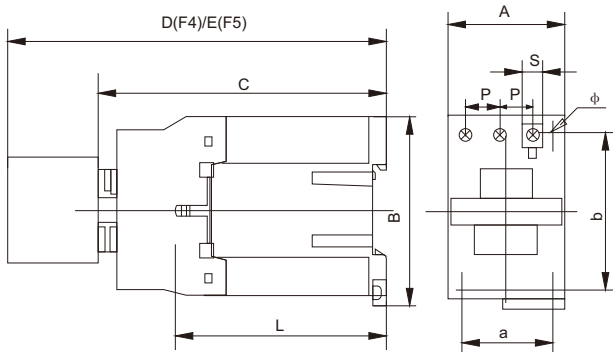

CC1-40Z~95Z

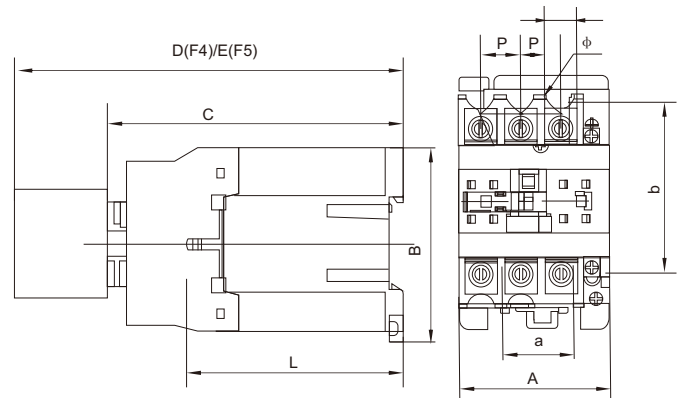

Note:

1. L: in main circuit, the distance between terminals and plate;
2. P: in main circuit, the distance between two phases;
3. S: in main circuit, the width of contacting plate.

Model	A max	B max	C max	D max	E max	a	b	φ	L	P	S
CC1-09(Z)~12(Z)	47	76	82(116)	120.5(154.5)	140.5(174.5)	34/35	50/60	4.5	60(95)	10.5	8.6
CC1-18(Z)	47	76	87(122)	125.5(160.5)	145.5(180.5)	34/35	50/60	4.5	61(96)	11.3	10.4
CC1-25(Z)	57	86	95(131)	133.5(169.5)	153.5(189.5)	40	48	4.5	70(107)	13.2	11.7
CC1-32(Z)	57	86	100(138)	138.5(176.5)	158.5(196.5)	40	48	4.5	71.6(120)	14.5	13
CC1-4011(Z)~6511(Z)	77	129	116(173)	154.5(211.5)	174.5(231.5)	40	100/110	6.5	78(135)	20	8.6
CC1-4004/4008(Z)~6504/6508(Z)	84	129	116(173)	154.5(211.5)	174.5(231.5)	40	100/110	6.5	78(135)	20	8.6
CC1-8011(Z)~9511(Z)	87	129	127(188)	165.5(226.5)	185.5(246.5)	40	100/110	6.5	83(140)	23.5	12
CC1-8004/8008(Z)~9504/9508(Z)	96	129	127(183)	160.5(221.5)	180.5(241.5)	40	100/110	6.5	83(140)	23.5	12



CC1-225

1. Description

- Application: remote making & breaking circuits; protect circuit from over-load when assembling with thermal over-load relay; frequent start-up and control of AC contactor;
- Electric value: AC50/60Hz, 690V, up to 800A;
- Utilization category: AC-3, AC-4;
- Altitude: ≤2000m;
- Ambient temperature: -5°C~+40°C;
- Mounting category: III;
- Mounting conditions: inclination between the mounting plane and the vertical plane should not exceed ±5° ;
- Standard: IEC/EN 60947-4-1

● Control Coil Voltage(AC Coil Operation)

Volts(VAC)		24	36	42	48	110	127	220	230	240	380	415	440	480	500	600
Code	50Hz	B5	C5	D5	E5	F5	G5	M5	P5	U5	Q5	N5	R5	-	S5	Y5
	60Hz	B6	-	D6	E6	F6	G6	M6	-	U6	Q6	-	R6	T6	-	-
	50/60Hz	B7	-	D7	E7	F7	-	M7	P7	-	Q7	N7	R7	-	-	-

● Control Coil Voltage(DC Coil Operation)

Volts(VDC)	12	24	36	48	110	220
Code	JD	BD	CD	ED	FD	MD



CC1-400

2. Type Designation

CC1-□□□□

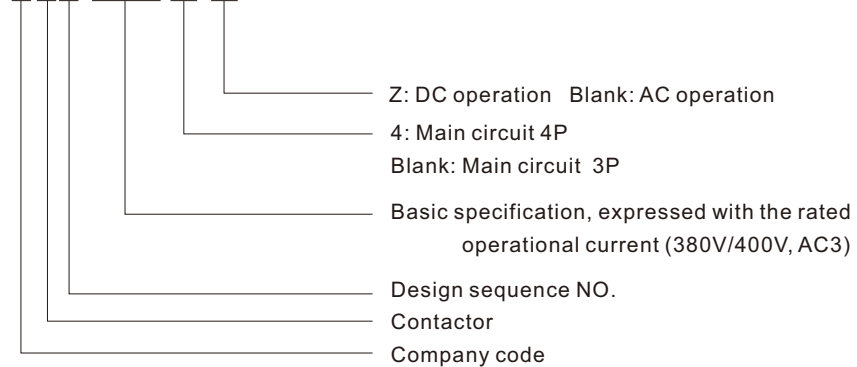

3. Technical Specification



CC1-630

Standard	IEC/EN60947-4-1						
Model No.		CC1-115	CC1-150	CC1-185	CC1-225	CC1-265	CC1-330
Rated Conventional Heating Current	Ith (A)	200	200	275	275	315	380
Rated Voltage Ui(V)	Ui(V)	690	690	690	690	690	690
Rated Operation Current Ue=380/415V	AC-3 Ie(A)	115	150	185	225	265	330
	AC-4 Ie(A)	52	60	79	86	105	117
Power Controlled 3ph cage Motor AC-3	380/415V KW	55	75	90	110	132	160
	660/690V KW	80	100	110	129	160	220
Electrical life (x10 ³ operations)	AC-3	600	600	300	300	300	300
	AC-4	100	100	100	100	100	100
Mechanical life (x10 ⁶ operations)		6	6	3	3	3	3
Matched Fuse	Size	RT16-1	RT16-2	RT16-2	RT16-2	RT16-2	RT16-3
	A	200	225	315	315	355	450
Main circuit		3P or 4P					



CC1-780

Standard	IEC/EN60947-4-1						
Model No.		CC1-400	CC1-500	CC1-630	CC1-780	CC1-800	CC1-1000
Rated Conventional Heating Current	Ith (A)	460	580	850	1200	850	1200
Rated Voltage Ui(V)	Ui(V)	690	690	690	690	690	690
Rated Operation Current Ue=380/415V	AC-3 Ie(A)	400	500	630	780	800	1000
	AC-4 Ie(A)	138	147	188	240	195	320
Power Controlled 3ph cage Motor AC-3	380/415V KW	200	250	335	400	400	500
	660/690V KW	280	335	450	475	475	560
Electrical life (x10 ³ operations)	AC-3	300	300	300	200	200	200
	AC-4	100	100	100	50	50	50
Mechanical life (x10 ⁶ operations))		3	3	3	2	3	2
Matched Fuse	Size	RT16-3	RT16-4	RT16-4	RT16-4	RT16-4	RT16-4
	A	500	630	800	1250	800	1250
Main circuit		3P or 4P					

Contactor 115~800A

Standard_ IEC60947-4-1

4. Terminal Connection

Model	Cabling(Cu)			Screw size	Tightening torque (N · m)
	Number of piece	Cable Cross section(mm) ²	Cu busbar Cross section(mm) ²		
CC1-115	1	70~90	-	M6	3
CC1-150	1	70~90	-	M8	6
CC1-185	1	95~150	-	M8	6
CC1-225	1	95~150	-	M10	10
CC1-265	1	120~185	-	M10	10
CC1-330	1	185~240	-	M10	10
CC1-400	1(2)	240(150)	30×5	M10	10
CC1-500	2	150~185	40×5	M10	10
CC1-630	2	185~240	50×5	M12	14
CC1-800	2	185~240	50×5	M12	14

5. Overall and Mounting Dimension (mm)

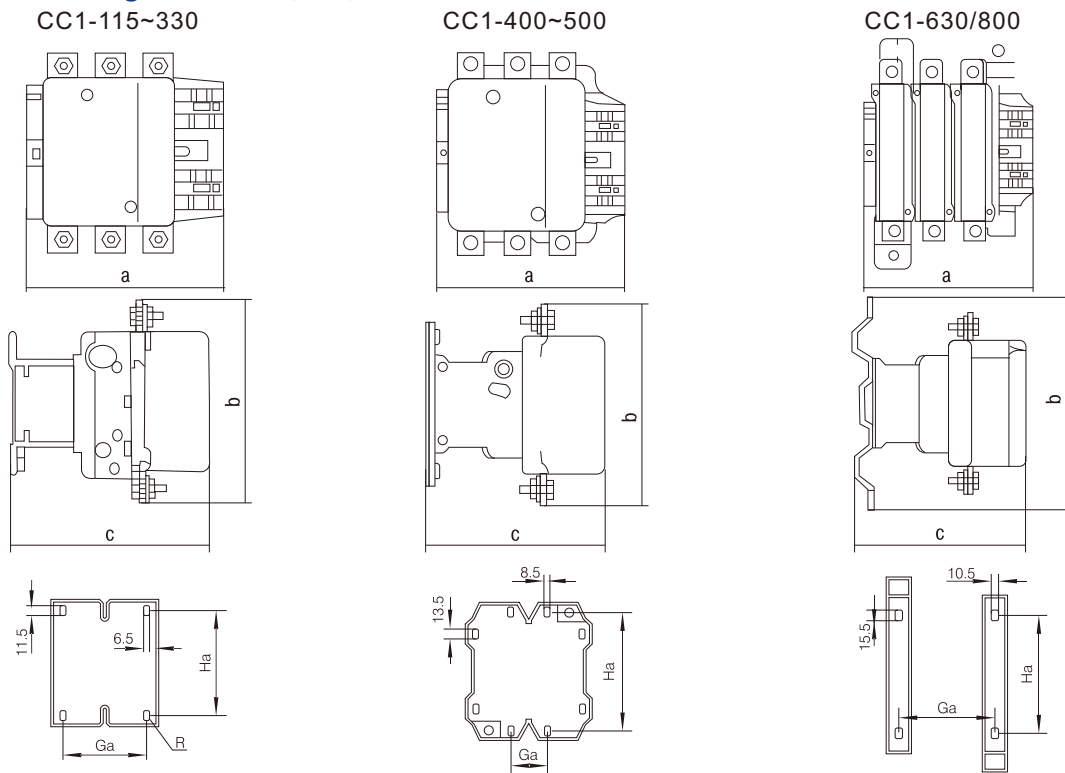

Model	A max	B max	C max
CC1-115	163.5	162	171
CC1-150	163.5	170	171
CC1-185	168.5	174	181
CC1-225	168.5	197	181
CC1-265	201.5	203	213
CC1-330	213	206	219
CC1-400	213	206	219
CC1-500	233	238	232
CC1-630/800	309	304	255



CJ19-25

1. Description

- Electric value: AC50/60Hz, up to 400V;
- Standard: IEC/EN 60947-4-1

- Ambient temperature: -5°C~+40°C, the average during 24 hours should not exceed +35°C;
- Altitude: ≤2000m;
- Atmosphere conditions: At mounting site, relative humidity not exceed 50% at the max temperature of +40°C, higher relative humidity is allowable under lower temperature. For example, RH could be 90% at +20°C, special measures should be taken to occurrence of dews;
- Pollution degree: 3
- Installation category: III
- Installation conditions : the inclination between installation plane and vertical plane is within ±5°
- Impact and shake: the products should locate in the places where there are no obvious impact and shake.

2. Type Designation

C J 19 □ □ □

Number of auxiliary contacts
 20: 2N/O, 11: 1N/O+1N/C
 02: 2N/C (CJ19-25~43)
 21: 2N/O+1N/C
 12: 1N/O+2N/C (CJ19-63~95)

Basic model code
 Design sequence NO.
 Capacitor Switching Contactor
 Company code



CJ19-63

Capacitor Switching Contactor

Standard_ IEC60947-4-1

3. Technical Specification

Standard	IEC/EN60947-4-1						
Model No.		CJ19-25	CJ19-32	CJ19-43	CJ19-63	CJ19-80	CJ19-95
Rated Conventional Heating Current	I _{th} (A)	25	32	43	63	80	95
Rated Work Current	415V/I _e (A)	18	25	32	60	80	95
Capacitor Controlled	220V/240V(Kvar)	6	9	10	15	18	22
	400V/440V(Kvar)	12	18	20	30	36	40
Rated Insulation Voltage	U _i (V)	690	690	690	690	690	690
Rated Operation Voltage Electrial life(x10 ³)	U _e (V)	400	400	400	400	400	400
	Times	120	120	120	100	100	100
Mechanical life(x10 ³)	Times	3000	3000	3000	3000	3000	3000
Restrained Surge Capacity	x I _e	15					
Auxiliary Contact	I _{th} =10A	AC-15 360VA;DC-13 33W					
	Control Capacity						
COIL PARAMETERS							
Coil Power(VA)	Start-up	76	110	110	230	230	230
	Holding	10	11	11	32	32	32
Rated Control Power	U _s (V)	24,36,48,110,220,380					
Pull time	Ms	12~22	15~24	15~24	20~26	20~35	20~35
Release time	Ms	4~12	5~19	5~19	8~12	6~20	6~20
Operation Range	Pick-up	(85%-110%)U _s					
	Drop-out	(20%-75%)U _s					

4. Overall and Mounting Dimension (mm)

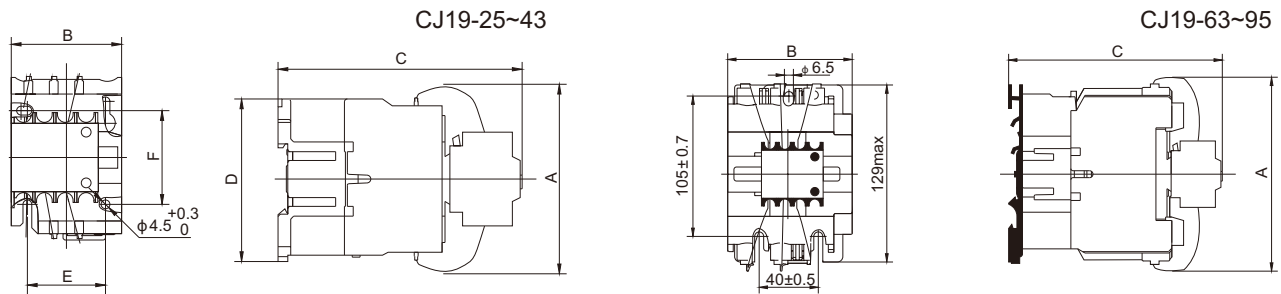

Model	Amax	Bmax	Cmax	Dmax	E	F	Note
CJ19-25	80	47	124	76	34/35	50/60	be fixed with 35mm din rail
CJ19-32	90	58	132	86	40	48	
CJ19-43	90	58	136	86	40	48	
CJ19-63	132	79	150	-	-	-	Not only fixed by screws but also could be fixed with 35mm and 75mm din rail
CJ19-80~95	135	87	158	-	-	-	

5. Wiring and installation

5.1 The connection terminals are protected through insulation cover, which is reliable and secure for installation and operation;

5.2 For CJ19-25~43, screws are available for installation, as well as the DIN rail;
for CJ19-63~95, 35mm or 75mm standard rail are available for installation.



CC1-0610E

1. Description

- Application: remote making & breaking circuits; protect circuit from over-load when assembling with thermal over-load relay; frequent start-up and control of AC contactor;
- Electric value: AC50/60Hz, 690V, up to 12A;
- Utilization category: AC-3, AC-4;
- Altitude: ≤2000m;
- Ambient temperature: -5°C~+40°C;
- Mounting category: III;
- Mounting conditions: inclination between the mounting plane and the vertical plane should not exceed ±5° ;
- Standard: IEC/EN 60947-4-1. IEC/EN 60947-5-1.

- Control Coil Voltage(AC Coil Operation)

Volts(VAC)	24	36	42	48	110	127	220	230	240	380	415	440	480	500	600	
Code	50Hz	B5	C5	D5	E5	F5	G5	M5	P5	U5	Q5	N5	R5	-	S5	Y5
	60Hz	B6	-	D6	E6	F6	G6	M6	-	U6	Q6	-	R6	T6	-	-
	50/60Hz	B7	-	D7	E7	F7	-	M7	P7	-	Q7	N7	R7	-	-	-

- Control Coil Voltage(DC Coil Operation)

Volts(VDC)	12	24	36	48	110	220
Code	JD	BD	CD	ED	FD	MD

2. Type Designation

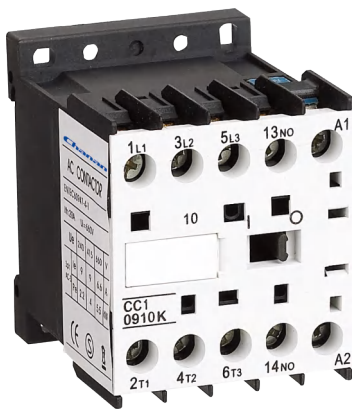

CC1-0910K

C C 1-□ □ □ □ □ □

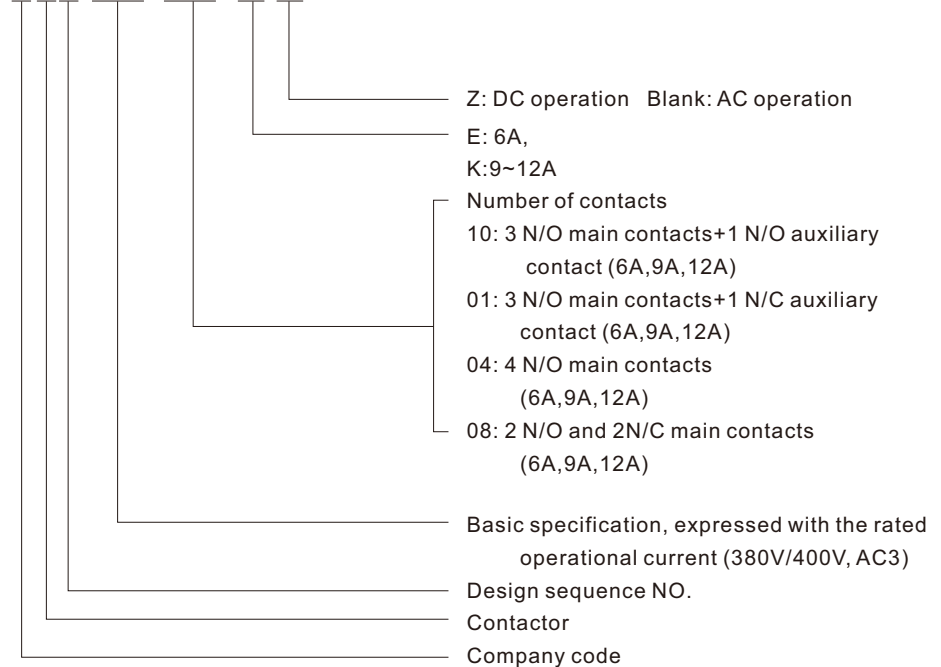

3. Technical Specification



CC1-0610E

Standard	IEC/EN60947-4-1 IEC/EN60947-5-1			
	Model No.	CC1-06E	CC1-09K	CC1-12K
Rated Conventional Heating Current	Ith (A)	16	20	20
Rated Voltage Ui(V)	Ui(V)	690	690	690
Rated Operation Current Ue=380/415V	AC-3 Ie(A)	6	9	12
	AC-4 Ie(A)	1.5	3.5	5
Power Controlled	220/240V KW	2.2	2.2	3
3ph cage Motor AC-3	380/415V KW	3	4	5.5
	660/690V KW	5.5	5.5	7.5
Electrical life(x10 ³ operations)	AC-3	1000	1000	1000
	AC-4	200	200	200
Mechanical life(x10 ⁶ operations))		10	10	10
Matched Fuse	Size	RT16-00	RT16-00	RT16-00
	A	20	20	20
Main circuit		3P or 4P		
Auxiliary circuit Cat.:AC-15,Ue=415V Ie=0.95A Ith=10A		1NO or 1NC		

4. Overall and Mounting Dimension (mm)



CC1-0910K

CC1-06E

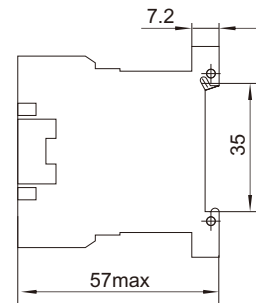
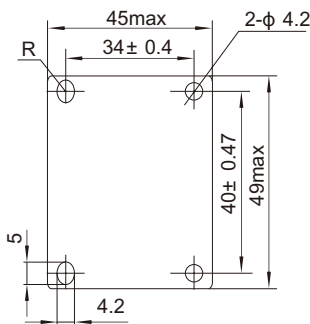

CC1-09~12K

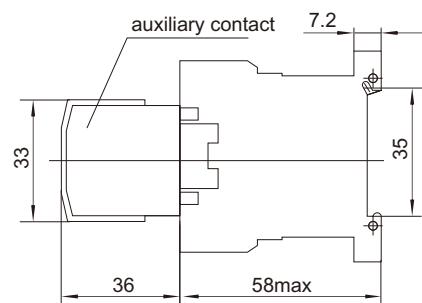
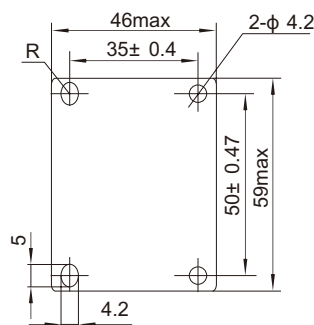



CR2-03

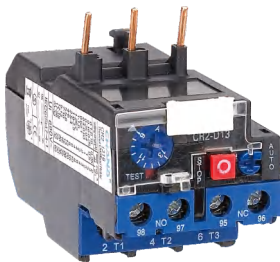

CR2-13



CR2-23



CR2-33

1. Description

- Electric value: AC 50/60Hz, 690V, 0.1A~630A;
- Tripping class: 10A;
- Mounting version:
 - a. Plug-in: Available for CR2-03,13,23,33,43;
 - b. Independent: Available for CR2-53, 63;
- Standard: IEC/EN 60947-4-1

2. Type Designation

C R 2-□ □ □ □

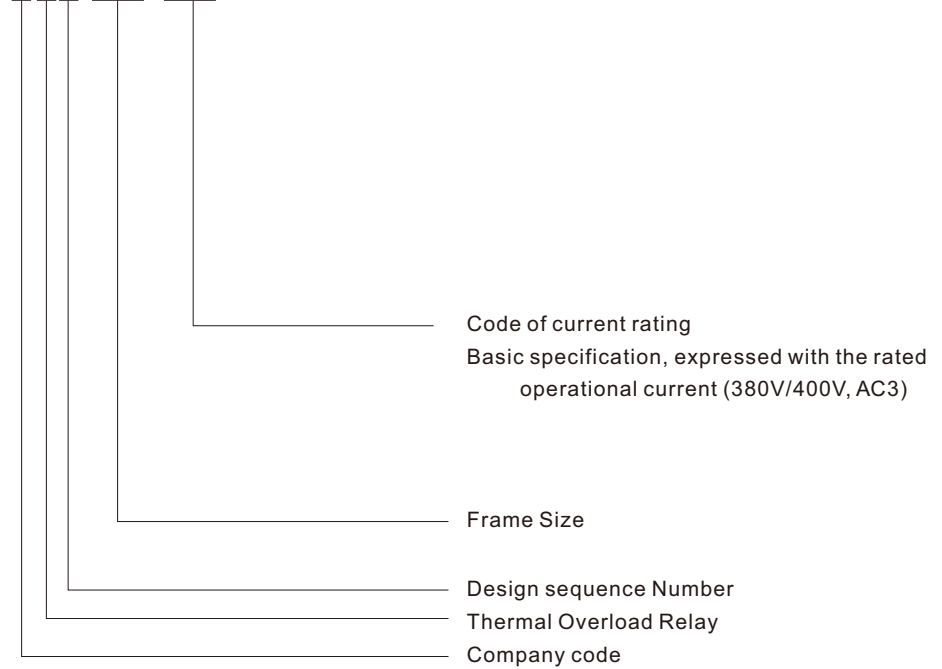

3. Feature

- 3.1 3-phase bimetal
- 3.2 Continuously readjustable current settings
- 3.3 Temperature compensation
- 3.4 Tripping indicator
- 3.5 Test button
- 3.6 Stop button
- 3.7 Manual and automatic reset button
- 3.8 Electrically separated 1N/O plus 1N/C contact

4. Technical Specification

4.1 Protection property

Item	Series No.	I/In	Operating time Tp	Test condition
Overload protection	1	1.05	>2 h	Start from cold status
	2	1.2	≤2h	Start from heat status, right after item No.1
	3	1.5	≤2min	Start from heat status, right after item No.1
	4	7.2	2s<Tp≤10s	Startfromcoldstatus
Phase failure protection	5	Any two phases	>2 h	Start from cold status
		1.0		
6	1.15	0	≤2 h	Start from heat status, right after item No.5

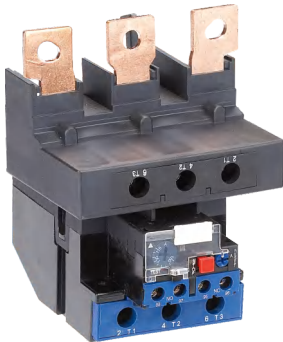

CR2-43

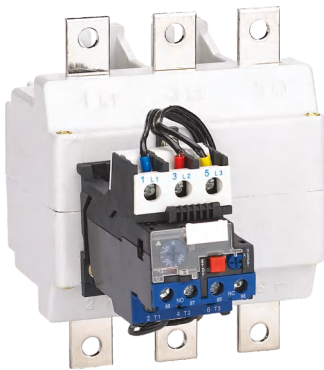

CR2-53

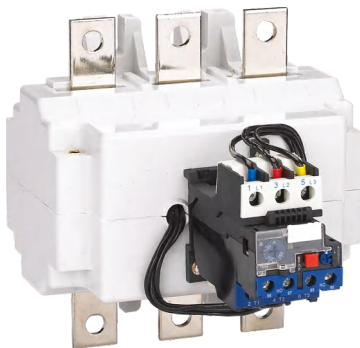

CR2-63

4.2 Curve

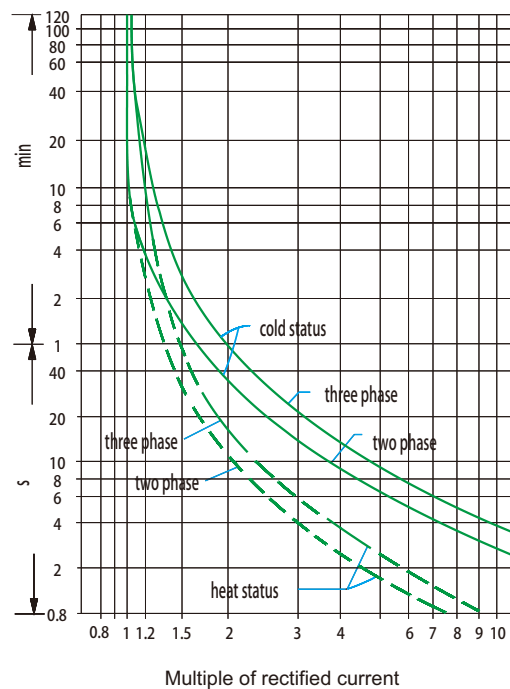

4.3 Main Technical Data

Phase failure protection function	Yes	
Automatic & manual reset	Yes	
Temperature compensation	Yes	
Tripping indicator	Yes	
Test & stop pushbutton	Yes	
Mounting mode	Plug-in	
	Independent	
No. of contacts	1N/O+1N/C	
Auxiliary contacts	Rated current (A) (AC-15 220V)	2.73
	Rated current (A) (AC-15 380V)	1.58
	Rated current (A) (DC-13 220V)	0.2

Thermal Overload Relay

Standard_ IEC60947-4-1

5. Assembly with contactor

Model of overload relay	Code	Rated current (A)	Recommended fuse type (RT16 is recommended)		Contactor Matched
			aM	gG	
CR2-03	0301	0.1~0.16	0.25	2	CC1-09K CC1-12K
	0302	0.16~0.25	0.5	2	
	0303	0.25~0.4	1	2	
	0304	0.4~0.63	1	2	
	0305	0.63~1	2	4	
	0306	1~1.6	2	4	
	0307	1.6~2.5	4	6	
	0308	2.5~4	6	10	
	0310	4~6	8	16	
	0312	5.5~8	12	20	
	0314	7~10	12	20	
0316	9~13	16	25		
CR2-13	1301	0.1~0.16	0.25	2	CC1-09 CC1-12 CC1-18 CC1-25 CC1-32
	1302	0.16~0.25	0.5	2	
	1303	0.25~0.4	1	2	
	1304	0.4~0.63	1	2	
	1305	0.63~1	2	4	
	1306	1~1.6	2	4	
	1307	1.6~2.5	4	6	
	1308	2.5~4	6	10	
	1310	4~6	8	16	
	1312	5.5~8	12	20	
	1314	7~10	12	20	
	1316	9~13	16	25	
	1321	12~18	20	35	
1322	17~25	25	50		
CR2-23	2353	23~32	40	63	CC1-32
	2355	30~40	40	80	
CR2-33	3353	23~32	40	63	CC1-40 CC1-50 CC1-65 CC1-80 CC1-95
	3355	30~40	40	100	
	3357	37~50	63	100	
	3359	48~65	63	100	
	3361	55~70	80	125	
	3363	63~80	80	125	
	3365	80~93	100	160	
CR2-43	4366	80~104	125	200	CC1-115 CC1-150
	4367	95~120	125	224	
	4368	110~150	160	250	
CR2-53	5369	80~125	125	200	CC1-115 CC1-185 CC1-150 CC1-225
	5370	100~160	160	250	
	5371	125~200	200	315	
CR2-63	6372	160~250	250	400	CC1-185 CC1-400 CC1-225 CC1-500 CC1-265 CC1-630 CC1-330
	6373	200~315	315	500	
	6374	250~400	400	630	
	6375	315~500	500	800	
	6376	400~630	630	800	

Thermal Overload Relay

Standard_ IEC60947-4-1

6. Overall and mounting dimension (mm)

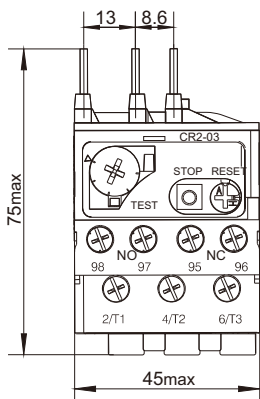

CR2-03

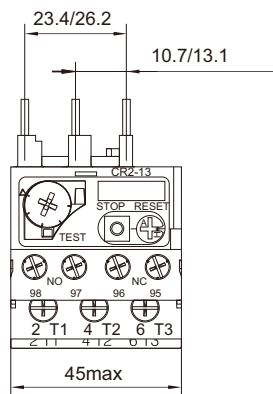
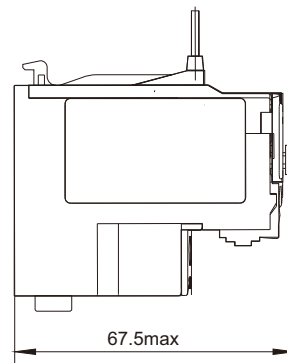

CR2-13

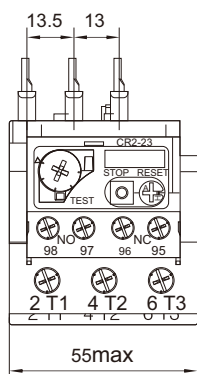
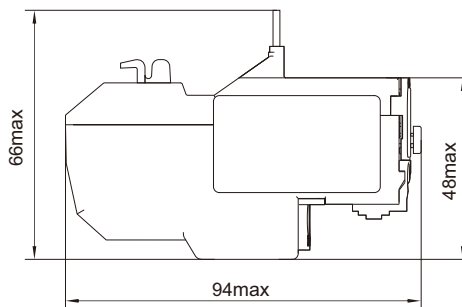

CR2-23

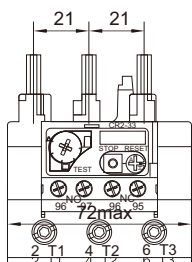
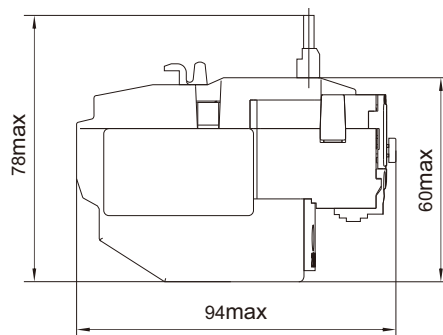

CR2-33

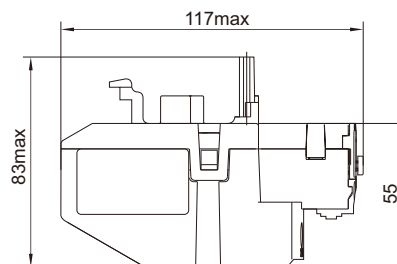

Thermal Overload Relay

Standard_ IEC60947-4-1

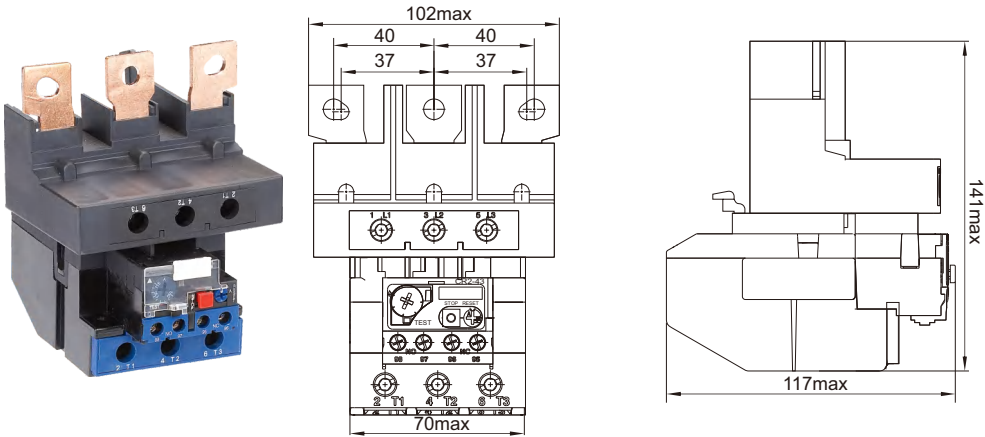

CR2-43

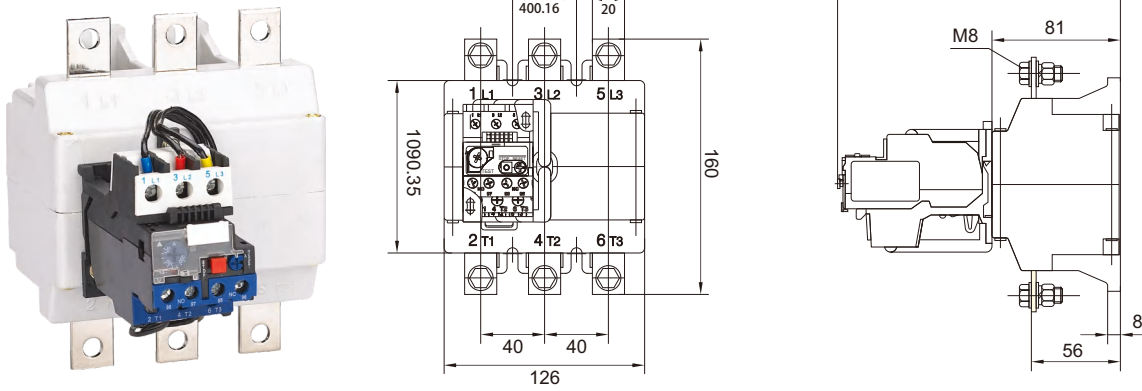

CR2-53

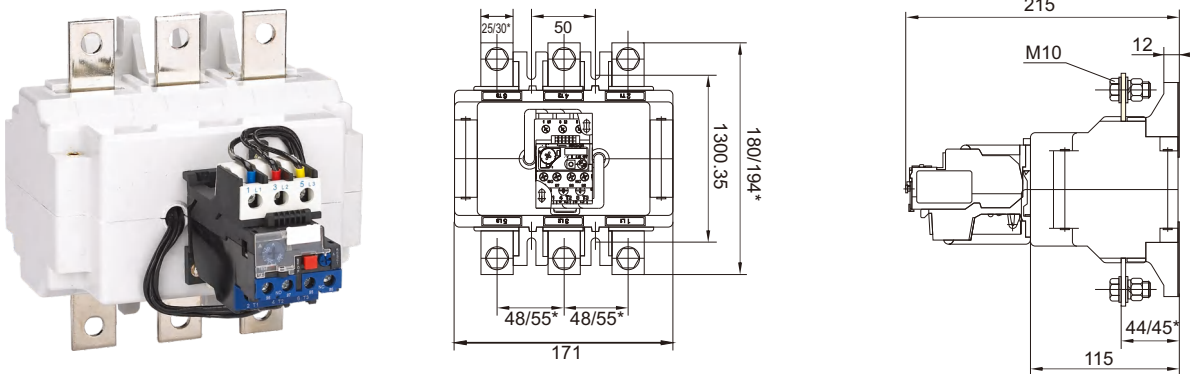

CR2-63

Note: Dimension with * for the product over 400A.

7. Wiring

Items			CR2-03	CR2-13	CR2-23	CR2-33	CR2-43	CR2-53	CR2-63
Cross section area of conductor mm ²	Main circuit	Single core or stranded wire	1~4	1~4	4~10	4~35	25~95	25~95	70~2×240
		Wiring screw	M3.5	M4	M4	M10	M6/M8	M8	M10
	Auxiliary circuit	Single core or stranded wire	0.5~2.5	0.5~2.5	0.5~2.5	0.5~2.5	0.5~2.5	0.5~2.5	0.5~2.5
		Wiring screw	M3.5	M3.5	M3.5	M3.5	M3.5	M3.5	M3.5

	Sepecification	Model	Contact Number	Contactors Matched
	Auxiliary Contact 4-pole Front mount	F4-40	4NO	CC1-09~95 CC1-115~800
		F4-31	3NO+1NC	
		F4-22	2NO+2NC	
		F4-13	1NO+3NC	
		F4-04	4NC	
	Auxiliary Contact 2-pole Front mount	F4-20	2NO	CC1-09~95 CC1-115~800
		F4-11	1NO+1NC	
		F4-02	2NC	
	Auxiliary Contact 2-pole Side mount	F8-20	2NO	CC1-09~95
		F8-11	1NO+1NC	
		F8-02	2NC	
	1NO+1NC Pneumatic timer ON-delay	F5-T0	0.1~3s	CC1-09~95 CC1-115~800
		F5-T2	0.1~30s	
		F5-T4	10~180s	
	1NO+1NC Pneumatic timer OFF-delay	F5-D0	0.1~3s	
		F5-D2	0.1~30s	
		F5-D4	10~180s	
	Auxiliary Contact 4-pole Front mount	F4-40K	4NO	CC1-09~12K
		F4-31K	3NO+1NC	
		F4-22K	2NO+2NC	
		F4-13K	1NO+3NC	
		F4-04K	4NC	
	Auxiliary Contact 2-pole Front mount	F4-20K	2NO	CC1-09~12K
		F4-11K	1NO+1NC	
		F4-02K	2NC	
	Contactor Coil	CX1-2	AC Volts	CC1-09~18
		CX1-4	AC Volts	CC1-25~32
		CX1-6	AC Volts	CC1-40~95
	Contactor Coil Water Proof	CX1-6N	AC Volts	CC1-40~95
		CX1-FF	AC Volts	CC1-115~150
		CX1-FG	AC Volts	CC1-185~225
		CX1-FH	AC Volts	CC1-265
		CX1-FJ	AC Volts	CC1-400
		CX1-FK	AC Volts	CC1-500
		CX1-FL	AC Volts	CC1-630
		CX1-FX	AC Volts	CC1-780

Standard_ IEC60947-4-1

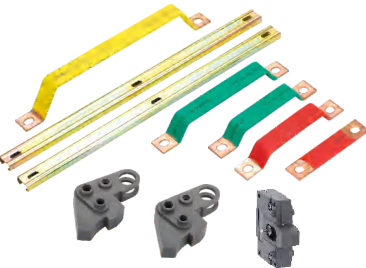
	Sepecification	Model	Contactor Matched
	Accessories for Reversing/change-over type contactor	CA9-0932	CC1-09~32
		CA9-4095	CC1-40~95
		CA9-FF970	CC1-115~150
		CA9-FG970	CC1-185~225
		CA9-FJ970	CC1-330~400
		CA9-FL970	CC1-630

	Sepecification	Model	TOR Matched
	Mounting Block for Thermal Overload Relay	CA9-1064	CR2-13
		CA9-2064	CR2-23
		CA9-3064	CR2-33

8. Mounting Sketch Map

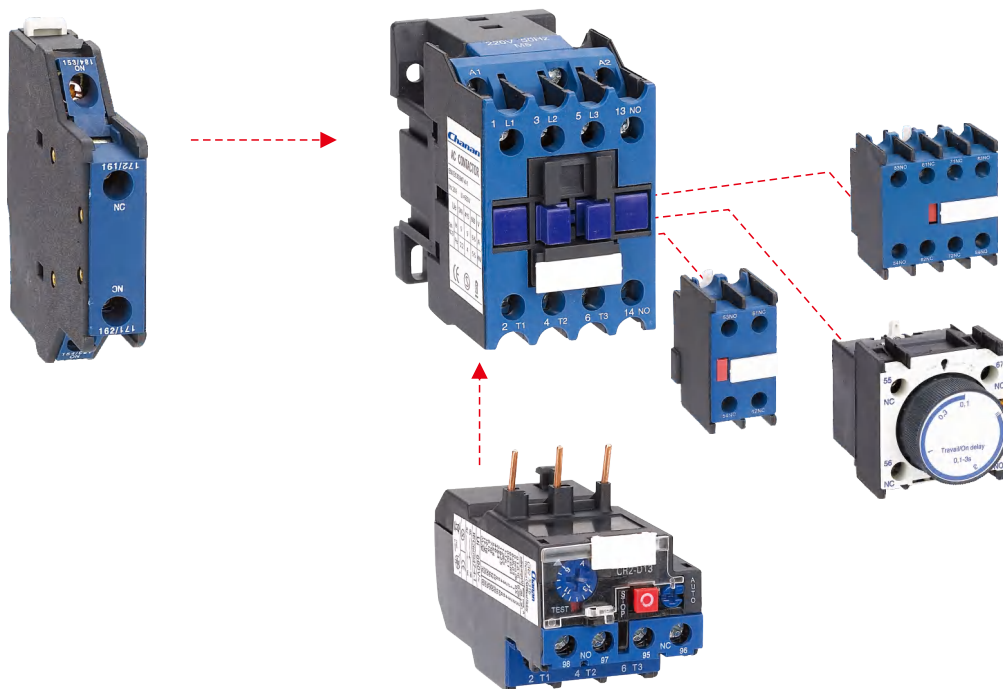



CQ1-09/18



CQ1-25/32



CQ1-40~95

1. Description

- CQ1 series electromagnetic starter ("starter" for short hereinafter) applies mainly to circuit with AC current of 50Hz (or 60Hz), rated operational voltage of 660V and rated controlled power up to 45kW (current up to 95A) for using to control the direct start and halt of the electromotor to protect the motor from overload and phase failure.
- The starter conforms to standards IEC/EN60947-4-1

2. Type Designation

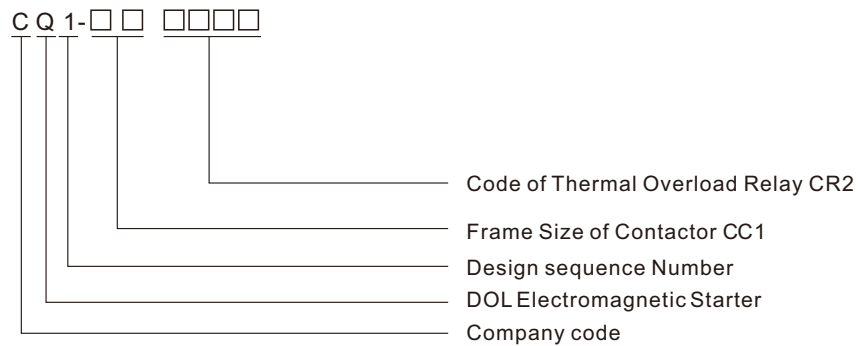

3. Feature

- 3.1 3-phase bimetal
- 3.2 Continuously readjustable current settings
- 3.3 Temperature compensation
- 3.4 Tripping indicator
- 3.5 Test button
- 3.6 Stop button
- 3.7 Manual and automatic reset button
- 3.8 Electrically separated 1N/O plus 1N/C contact

4. Wiring Diagram

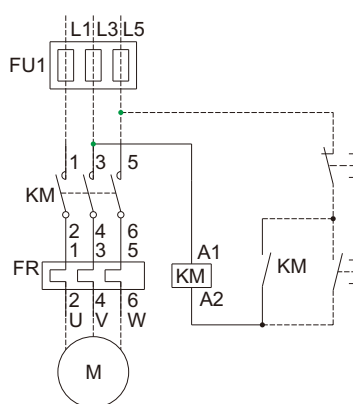

Control supply voltage is as the same as the main circuit voltage (three-phase)

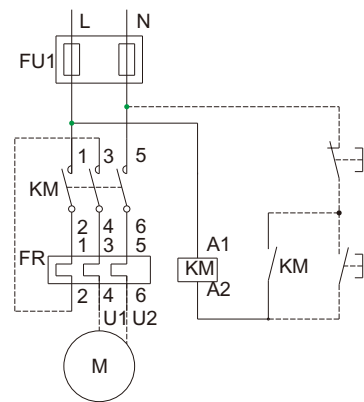

Control supply voltage is as the same as the main circuit voltage (single-phase)

DOL Electromagnetic Starter

Standard_ IEC60947-4-1

1 Basic Model and main technical parameter of the starter

Model	Range of setting current A	current (A)	Maximum rated Power (kW)			Model of equipped AC contactor	TOR matched
			AC-3				
			660V	380V	220V		
CQ1-09/1301	0.1~0.16	9	5.5	4	2.2	CC1-09	CR2-13
CQ1-09/1302	0.16~0.25						
CQ1-09/1303	0.25~0.4						
CQ1-09/1304	0.4~0.63						
CQ1-09/1305	0.63~1						
CQ1-09/1306	1~1.6						
CQ1-09/1307	1.6~2.5						
CQ1-09/1308	2.5~4						
CQ1-09/1310	4~6						
CQ1-09/1312	5.5~8						
CQ1-09/1314	7~10	18	10	7.5	4	CC1-18	CR2-13
CQ1-18/1314	7~10						
CQ1-18/1316	9~13						
CQ1-18/1321	12~18	25	15	11	5.5	CC1-25	CR2-13
CQ1-25/1321	12~18						
CQ1-25/1322	17~25	32	18.5	15	7.5	CC1-32	CR2-23
CQ1-32/2353	23~32						
CQ1-40/3355	30~40	40	30	18.5	11	CC1-40	CR2-33
CQ1-50/3357	37~50	50	33	22	15	CC1-50	CR2-33
CQ1-65/3359	48~65	65	37	30	18.5	CC1-65	CR2-33
CQ1-80/3361	55~70	80	45	37	22	CC1-80	CR2-33
CQ1-80/3363	63~80						
CQ1-95/3365	80~93	95	45	45	25	CC1-95	CR2-33

5. Overall and Mounting Dimension (mm)

CQ1-09~32(Steel base + Plastic cover)

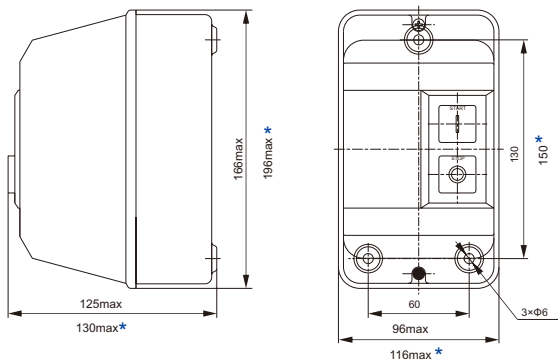

CQ1-40~95(Steel base + Steel cover)

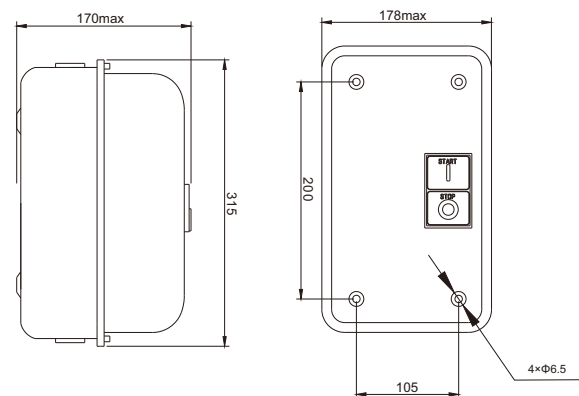

Note: Dimension with * for CQ1-25~32



CQ2-09/18



CQ2-25/32



CQ2-40~95

1. Description

- CQ2 series electromagnetic starter ("starter" for short hereinafter) applies mainly to circuit with AC current of 50Hz (or 60Hz), rated operational voltage of 660V and rated controlled power up to 15kW (current up to 32A) for using to control the direct start and halt of the electromotor to protect the motor from overload and phase failure.
- The starter conforms to standards IEC/EN60947-4-1

2. Type Designation

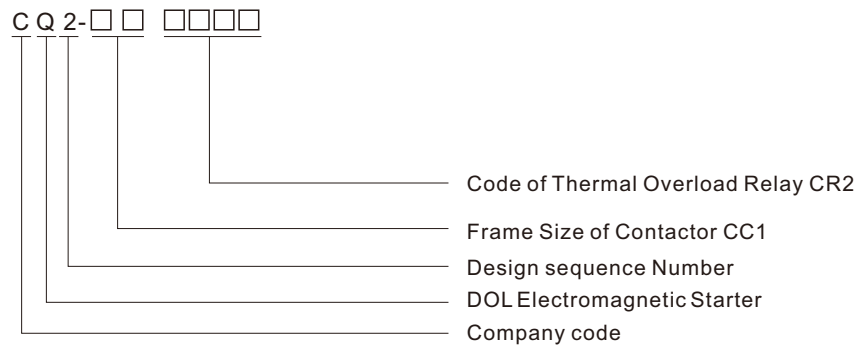

3. Feature

- 3.1 3-phase bimetal
- 3.2 Continuously readjustable current settings
- 3.3 Temperature compensation
- 3.4 Tripping indicator
- 3.5 Test button
- 3.6 Stop button
- 3.7 Manual and automatic reset button
- 3.8 Electrically separated 1N/O plus 1N/C contact

4. Wiring Diagram

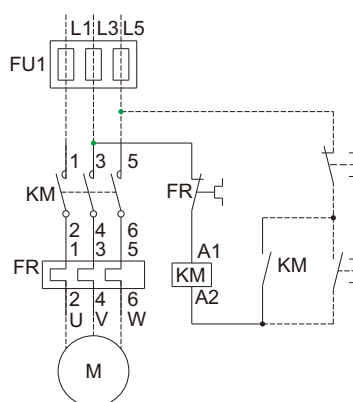

Control supply voltage is as the same as the main circuit voltage (three-phase)

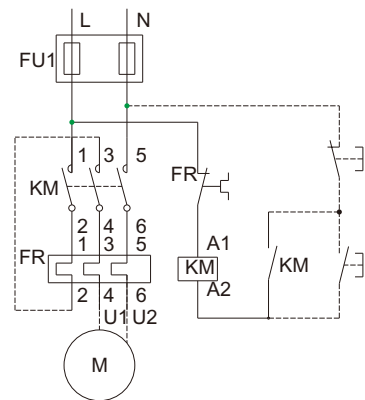

Control supply voltage is as the same as the main circuit voltage (single-phase)

DOL Electromagnetic Starter

Standard_ IEC60947-4-1

Basic Model and main technical parameter of the starter

Model	Range of setting current A	current (A)	Maximum rated Power (kW)			Model of equipped AC contactor	TOR matched
			AC-3				
			660V	380V	220V		
CQ2-09/1301	0.1~0.16	9	5.5	4	2.2	CC1-09	CR2-13
CQ2-09/1302	0.16~0.25						
CQ2-09/1303	0.25~0.4						
CQ2-09/1304	0.4~0.63						
CQ2-09/1305	0.63~1						
CQ2-09/1306	1~1.6						
CQ2-09/1307	1.6~2.5						
CQ2-09/1308	2.5~4						
CQ2-09/1310	4~6						
CQ2-09/1312	5.5~8						
CQ2-09/1314	7~10	18	10	7.5	4	CC1-18	CR2-13
CQ2-18/1314	7~10						
CQ2-18/1316	9~13						
CQ2-18/1321	12~18	25	15	11	5.5	CC1-25	CR2-13
CQ2-25/1321	12~18						
CQ2-25/1322	17~25	32	18.5	15	7.5	CC1-32	CR2-23
CQ2-32/2353	23~32						
CQ2-40/3353	30~40	40	30	18.5	11	CC1-40	CR2-33
CQ2-50/3357	37~50	50	33	22	15	CC1-50	CR2-33
CQ2-65/3359	48~65	65	37	30	18.5	CC1-65	CR2-33
CQ2-80/3361	55~70	80	45	37	22	CC1-80	CR2-33
CQ2-80/3363	63~80						
CQ2-95/3365	80~93	95	45	45	25	CC1-95	CR2-33

5. Overall and Mounting Dimension (mm)

CQ2-09~18(Plastic base + Plastic cover)

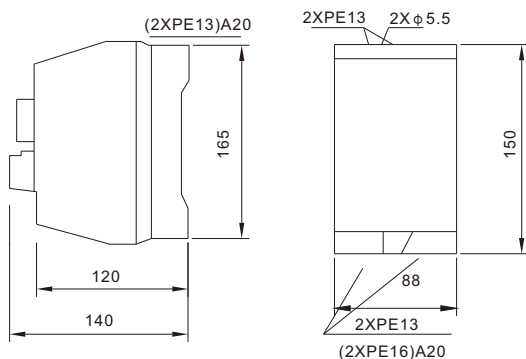

CQ2-25~32(Plastic base + Plastic cover)

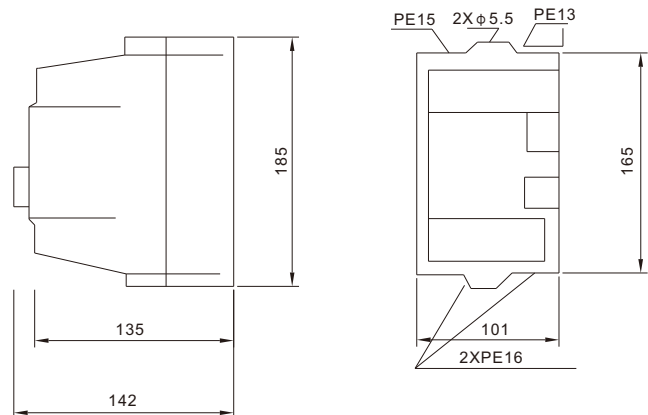

Note: Dimension of CQ2-40~95 is same as CQ1-40~95



CS2-32



CS2-80

1. Description

- Electric value: AC690V, 32A, 80A;
- Standard: IEC/EN 60947-2, IEC60947-4-1

2. Type Designation

C S 2-□□□□

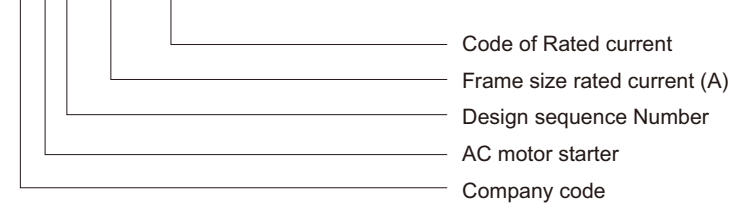

3. Operating Condition

- 3.1 Temperature: -5 °C ~ +40°C, average temperature in 24 hours not exceed +35 °C
- 3.2 Altitude: not exceed 2000m
- 3.3 Air conditions:
 - At mounting site, relative humidity not exceed 50% at the max temperature of +40°C, higher relative humidity is allowable under lower temperature, for example, RH could be 90% at +20°C
- 3.4 Pollution grade: Grade III
- 3.5 Release grade: 10A(CS2-32) 10A(CS2-80)
- 3.6 Rated operational system: Continuous operational system
- 3.7 Mounting conditions:
 - The inclination between the mounting plane and the vertical plane shall not exceed 5°
 - The product shall be installed and operated at a place without obvious shake, Impact and vibration.

4. Technical Specification

4.1 Protection property

Over-load Protection Properties

Series No.	Multiple of setting current	Initial status	Time	Expected results	Ambient temperature	
1	1.05	Cold status	$t \geq 2h$	Non-tripping	$+20^{\circ}C \pm 2^{\circ}C$	
2	1.20	Heat status (right after test.1)	$t < 2h$	Tripping	$+20^{\circ}C \pm 2^{\circ}C$	
3	1.50	Heat status (right after test.1)	Tripping class	10A $t < 2min$	Tripping	$+20^{\circ}C \pm 2^{\circ}C$
				10 $t < 4min$		
4	7.20	Cold status	Tripping class	10A $2s < t \leq 10s$	Tripping	$+20^{\circ}C \pm 2^{\circ}C$
				10 $4s < t \leq 10s$		

Phase failure protection properties

Series No.	Multiple of setting current		Initial status	Time	Expected results	Ambient temperature
	Any 2 phase	The other phase				
1	1.0	0.9	Cold status	$t \geq 2h$	Non-tripping	$+20^{\circ}C \pm 2^{\circ}C$
2	1.15	0	Heat status (right after test.1)	$t < 2h$	Tripping	$+20^{\circ}C \pm 2^{\circ}C$

Temperature compensation properties

Series No.	Multiple of setting current	Initial status	Time	Expected results	Ambient temperature
1	1.0	Cold status	$t \geq 2h$	Non-tripping	$+40^{\circ}C \pm 2^{\circ}C$
2	1.2	Heat status (right after test.1)	$t < 2h$	Tripping	$+40^{\circ}C \pm 2^{\circ}C$
3	1.05	Cold status	$t \geq 2h$	Non-tripping	$-5^{\circ}C \pm 2^{\circ}C$
4	1.3	Heat status (right after test.3)	$t < 2h$	Tripping	$-5^{\circ}C \pm 2^{\circ}C$

Motor Protection Circuit Breaker

Standard_ IEC60947-2

Model of overload relay	Code	Rated current (A)	Rated ultimate short-circuit breaking capacity I _{cu} (kA)			Rated service short-circuit breaking capacity I _{cs} (kA)			Standard rated power of three-phase motor (kW)		
			230/240V	400/415V	660/690V	230/240V	400/415V	660/690V	230/240V	400/415V	660/690V
CS2-32	3201	0.1~0.16	100	100	100	100	100	100	-	-	-
	3202	0.16~0.25	100	100	100	100	100	100	-	-	-
	3203	0.25~0.4	100	100	100	100	100	100	-	-	-
	3204	0.4~0.63	100	100	100	100	100	100	-	-	0.37
	3205	0.63~1	100	100	100	100	100	100	-	-	0.55
	3206	1~1.6	100	100	100	100	100	100	-	-	1.1
	3207	1.6~2.5	100	100	3	100	100	2.25	0.37	0.75	1.5
	3208	2.5~4	100	100	3	100	100	2.25	0.75	1.5	3
	3210	4~6.3	100	100	3	100	100	2.25	1.1	2.2	4
	3214	6~10	100	100	3	100	100	2.25	2.2	4	7.5
	3216	9~14	100	15	3	100	7.5	2.25	3	5.5	9
	3220	13~18	100	15	3	100	7.5	2.25	4	9	11
	3221	17~23	50	15	3	50	6	2.25	5.5	11	15
	3222	20~25	50	15	3	50	6	2.25	5.5	11	18.5
CS2-80	8025	16~25	-	15	-	-	7.5	-	5.5	11	-
	8040	25~40	-	15	-	-	7.5	-	11	22	-
	8063	40~63	-	15	-	-	7.5	-	15	33	-
	8080	56~80	-	15	-	-	7.5	-	22	45	-

5. Accessory

5.1 Under-voltage release



Rated insulation voltage U _i (V)	Voltage range of operation	Model	Specification
690	35%~70%U _e	CS2-UV110	110~115V 50Hz
690	35%~70%U _e	CS2-UV127	127V 60Hz
690	35%~70%U _e	CS2-UV220	220~240V 50Hz
690	35%~70%U _e	CS2-UV380	380~400V 50Hz
690	35%~70%U _e	CS2-UV440	440V 60Hz

5.2 Shunt release



Rated insulation voltage U _i (V)	Voltage range of operation	Model	Specification
690	70%~110%U _e	CS2-SH110	110~115V 50Hz
690	70%~110%U _e	CS2-SH127	127V 60Hz
690	70%~110%U _e	CS2-SH220	220~240V 50Hz
690	70%~110%U _e	CS2-SH380	380~400V 50Hz
690	70%~110%U _e	CS2-SH440	440V 60Hz

5.3 Instantaneous auxiliary contact

5.3.1 NS2-AE20, NS2-AE11



Rated insulation voltage U _i (V)	Conventional heating current I _{th} (A)	Model	Configuration
250	2.5	CS2-AE20	2N/O
250	2.5	CS2-AE11	1N/O+1N/C

LED Indicator (φ22mm)

Standard_ IEC60947-5-1

LED INDICATOR

Application

AD22 series indicator light are used in the telecommunication and electrical circuit of AC 50Hz or 60Hz, rated working voltage 380V and below DC working voltage 220V or below for indicator signal, accident signal, fault signal and other indicator signals, they meet with the standard: IEC60947-5-1.

Structure and Function

AD22 series indicator lights adopt LED lamp with the characteristic of long life and low energy consumption, its concealed terminal is both safe and creditable. The special locking nut structure makes the installation available in the dimension of

AD22-22: φ 22.5 mm to φ 25.5mm,
AD22-16: φ 16.5 mm to φ 16.5mm.







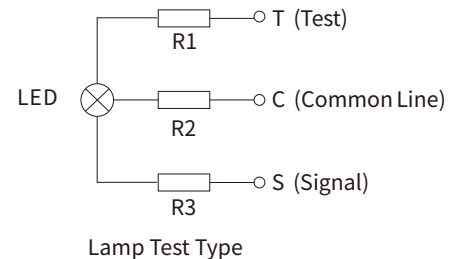
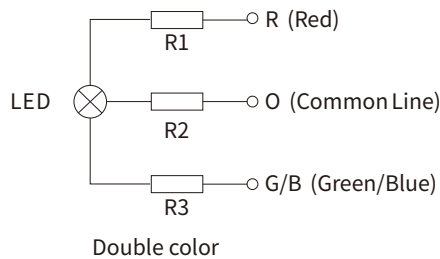
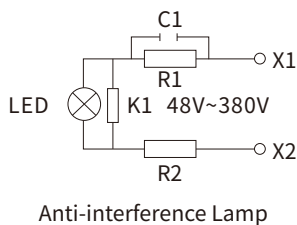
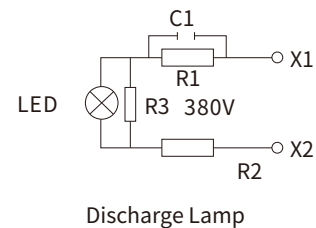
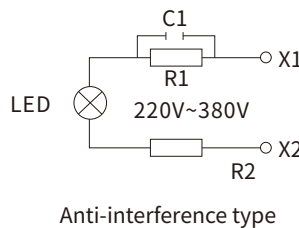
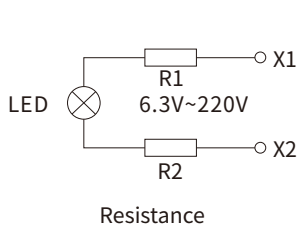







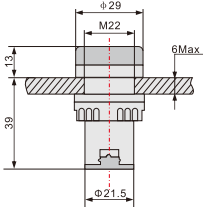





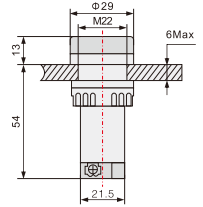





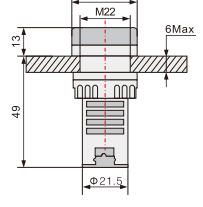



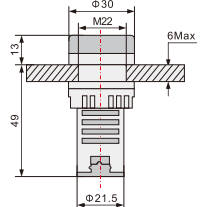



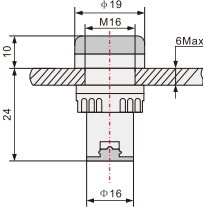

ELECTRIC

Schematic Diagram

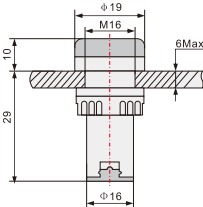

Man Technical Parameter

Operation temperature: -5°C~+40°C	Power-frequency withstand voltage: 2500V, min
Operation humidity: 45%~85%	Installation degree: III
Pollution degree: 3	Degree of protection: IP65
Rated operation voltage	(Ue) AC/DC 9V AC/DC 12V AC/DC 24V AC/DC 48V AC/DC 110V AC/DC 220V AC 380V
Rated operation current	(Ie) ≤80mA ≤20mA
Base colour	Green Yellow Red Blue White
Electrical Life(h)	≥3000
Brightness	≥60

Indicator	Description	Voltage	Color	Type	Outline Dimensions
	Protected LED Indicator $\phi 22$	6.3V AC/DC	 Red	AD22-22DS	
		12V AC/DC	 Yellow	General type	
		24V AC/DC	 Green	AD22-22DKS	
		48V AC/DC	 Blue	Anti-interference type	
		110V AC/DC	 White	AD22-22DFS	
		220V AC/DC 380V AC		Discharge Lamp	
	Protected LED Indicator Double color $\phi 22$	6.3V AC/DC	 Red	AD22-22DRG	
		12V AC/DC	 Green		
		24V AC/DC			
		48V AC/DC			
		110V AC/DC	 Red	AD22-22DRB	
		220V AC/DC 380V AC	 Blue		
	Protected LED Indicator Buzzer $\phi 22$	6.3V AC/DC	 Red	AD22-22MSD	
		12V AC/DC		Flash buzzer type	
		24V AC/DC			
		48V AC/DC			
		110V AC/DC	 Black	AD22-22MFD	
		220V AC/DC 380V AC		Buzzer type	
	Protected LED Indicator Lamp Test Type $\phi 22$	6.3V AC/DC	 Red	AD22-22DLT	
		12V AC/DC	 Yellow		
		24V AC/DC	 Green		
		48V AC/DC	 Blue		
		110V AC/DC	 White		
		220V AC/DC 380V AC			
	Protected LED Indicator $\phi 16$	6.3V AC/DC	 Red	AD22-16DS	
		12V AC/DC	 Yellow		
		24V AC/DC	 Green		
		48V AC/DC	 Blue		
		110V AC/DC	 White		
		220V AC/DC 380V AC			
	Protected LED Indicator $\phi 16$	6.3V AC/DC	 Red	AD22-16D	
		12V AC/DC	 Yellow		
		24V AC/DC	 Green		
		48V AC/DC	 Blue		
		110V AC/DC	 White		
		220V AC/DC 380V AC			

LED Indicator with Voltage Meter (φ22mm)

Standard_ IEC60947-5-1

Mode and Explanation

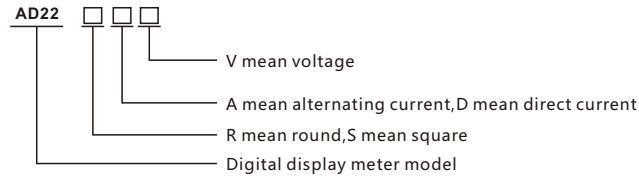

Summary

Mini digital display voltage meter
 AD22 series products two-wire three-way AC, DC digital display voltage meter.
 Products use 2.5 inches long life LED digital tube display with compact square enclosure, convenient installation.
 Products measurement range AC 80V-500V, DC 8-150V, frequency 50/60HZ.
 Products use two wire system, AC connected in zero line and fire line directly,
 DC have polarity reverse connection protection function .



Working Condition

Ambient temperature: -10 ~ +55 °C; Air relative humidity: 10-80% (no condensation)
 Working pressure: 80-106KPa; Sunniness: no sunniness

Technical parameter

Working voltage: AC 80-500V, DC 8-150V;
 Working frequency: 50/60HZ;
 Working current: ≤20MA;
 Measuring accuracy: 1.0;
 Measuring rate: >200MS/time;
 Mounting-hole size: φ22mm;

Style	Name	Type	Color	voltage	Outine Dimensions
	Φ22 Mini Digital Display Meter	AD22-RAV	<ul style="list-style-type: none"> White Green Red Yellow Blue 	AC80-500V	
	Φ22 Mini Digital Display Meter	AD22-SAV	<ul style="list-style-type: none"> White Green Red Yellow Blue 	AC80-500V	
	Φ22 Mini Digital Display Meter	AD22-RDV	<ul style="list-style-type: none"> White Green Red Yellow Blue 	DC8-150V	
	Φ22 Mini Digital Display Meter	AD22-SDV	<ul style="list-style-type: none"> White Green Red Yellow Blue 	DC8-150V	

Pushbutton Switch (φ22mm)

Standard_ IEC60947-5-1

Pushbutton Switch

Application

CB* - series pushbutton switches are used in industrial for controlling circuits of AC 50Hz or 60Hz, rated operation voltage 380V or below and DC operational Voltage 220V or below for controlling in magnetic starter, contactor, relay and other electrical circuits. The buttons indicators can also be used in the place with indicated light or signal. They meet with the standards :IEC60947-5-1.







Man Technical Parameter

Operation temperature	-5°C~+40°C					
Power-frequency withstand voltage	2500V, 1min					
Operation humidity	45%~85%					
Electric durability	50×10 ⁴					
Contact resistance	≤50mΩ					
Degree of protection	IP40					
Rated insulation voltage	Ui	660V				
Conventional thermal current	Ith	10A				
Rated operation voltage	Ue	380V	220V	110V	48V	24V
Rated operation current	AC-15	2.5A	4.5	6A	8A	-
	DC-13	-	0.3A	0.6A	1.3A	2.5



Rated operational Voltage	Directness						Resistance		Transformer	
	6V	12V	24V	48V	110V	220V	380V	220V	220V	380V
LED lamp	√	√	√	—	—	—	—	—	√	√
Neon lamp	—	—	—	—	√	√	√	√	—	—
Incandescence lamp	√	√	√	√	√	√	√	—	√	√



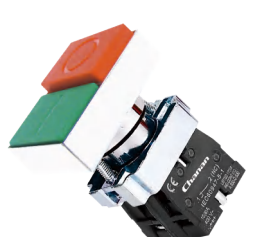
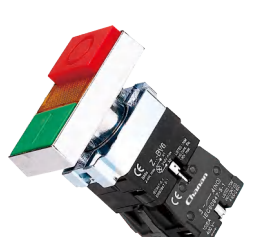

Plastic Type	Description	Type	Scheme	color
	Flush button spring return	CB2-EA11	N/O	○ White
		CB2-EA21	N/O	● Black
		CB2-EA31	N/O	● Green
		CB2-EA51	N/O	● Yellow
		CB2-EA61	N/O	● Blue
		CB2-EA42	N/C	● Red
		CB2-EA25	N/O+N/C	● Black
		CB2-EA35	N/O+N/C	● Green
		CB2-EA45	N/O+N/C	● Red
	Button with protective cover IP65	CB2-EP11	N/O	○ White
		CB2-EP21	N/O	● Black
		CB2-EP31	N/O	● Green
		CB2-EP51	N/O	● Yellow
		CB2-EP61	N/O	● Blue
		CB2-EP42	N/C	● Red
		CB2-EP25	N/O+N/C	● Black
		CB2-EP35	N/O+N/C	● Green
		CB2-EP45	N/O+N/C	● Red
	Protruding button	CB2-EL11	N/O	○ White
		CB2-EL21	N/O	● Black
		CB2-ELP31	N/O	● Green
		CB2-EL51	N/O	● Yellow
		CB2-EL61	N/O	● Blue
		CB2-EL42	N/C	● Red
		CB2-EL25	N/O+N/C	● Black
		CB2-EL35	N/O+N/C	● Green
		CB2-EL45	N/O+N/C	● Red
	Standard handle knob	CB2-ED21	N/O	∨
		CB2-ED25	N/O+N/C	∨
		CB2-ED41	N/O	∨
		CB2-ED45	N/O+N/C	∨
		CB2-ED33	2NO	∨
		CB2-ED53	2NO	∨
	Long handle knob	CB2-EJ21	N/O	∨
		CB2-EJ25	N/O+N/C	∨
		CB2-EJ41	N/O	∨
		CB2-EJ45	N/O+N/C	∨
		CB2-EJ33	2NO	∨
		CB2-EJ53	2NO	∨

Plastic Type	Description	Type	Scheme	color
	Key button	CB2-EG21	N/O	↘
		CB2-EG25	N/O+N/C	↘
		CB2-EG41	N/O	↘↗
		CB2-EG45	N/O+N/C	↘↗
		CB2-EG61	N/O	↘↗
		CB2-EG65	N/O+N/C	↘↗
		CB2-EG03	2NO	↕↗
		CB2-EG33	2NO	↕
		CB2-EG53	2NO	↕↗
		CB2-EG73	2NO	↕↗
	Double head button	CB2-EL8325	N/O+N/C	<div style="display: flex; gap: 5px;"> ■ Green</div> <div style="display: flex; gap: 5px;"> ■ Red</div>
		CB2-EL8425	N/O+N/C	<div style="display: flex; gap: 5px;"> ■ Green</div> <div style="display: flex; gap: 5px;"> ■ Red</div>
	Double head button with lamp 6V~380V	CB2-EW8365 (Directness)	N/O+N/C	<div style="display: flex; gap: 5px;"> ■ Green</div> <div style="display: flex; gap: 5px;"> ■ Yellow</div> <div style="display: flex; gap: 5px;"> ■ Red</div>
		CB2-EW8465 (Directness)	N/O+N/O	<div style="display: flex; gap: 5px;"> ■ Green</div> <div style="display: flex; gap: 5px;"> ■ Yellow</div> <div style="display: flex; gap: 5px;"> ■ Red</div>
		CB2-EW8375 (Resistance)	N/O+N/C	<div style="display: flex; gap: 5px;"> ■ Green</div> <div style="display: flex; gap: 5px;"> ■ Yellow</div> <div style="display: flex; gap: 5px;"> ■ Red</div>
		CB2-EW8475 (Resistance)	N/O+N/C	<div style="display: flex; gap: 5px;"> ■ Green</div> <div style="display: flex; gap: 5px;"> ■ Yellow</div> <div style="display: flex; gap: 5px;"> ■ Red</div>
	Mushroom button spring return	φ 40 CB2-EC21	N/O	● Black
		φ 40 CB2-EC31	N/O	● Green
		φ 40 CB2-EC42	N/C	● Red
		φ 40 CB2-EC51	N/O	● Yellow
		φ 60 CB2-ER21	N/O	● Black
		φ 60 CB2-ER31	N/O	● Green
		φ 60 CB2-ER42	N/C	● Red
		φ 60 CB2-ER52	N/O	● Yellow
	Mushroom rotation auto-reset emergency button	φ 30 CB2-ES442	N/C	● Red
		φ 40 CB2-ES542	N/C	● Red
		φ 60 CB2-ES642	N/C	● Red

Plastic Type	Description	Type	Scheme	color
	Push and pull type emergency button	φ 40 CB2-ET42	N/C	● Red
		φ 40 CB2-ET845	N/O+N/C	● Red
	Mushroom rotation auto-reset emergency button with key	φ 40 CB2-ES142	N/C	● Red
		φ 40 CB2-ES8445	N/O+N/C	● Red
	Indicator light 6V~380V	Directness CB2-EV61		○ White
		Directness CB2-EV63		● Green
		Directness CB2-EV64		● Red
		Directness CB2-EV65		● Yellow
		Directness CB2-EV66		● Blue
		Resistance CB2-EV71		○ White
		Resistance CB2-EV73		● Green
		Resistance CB2-EV74		● Red
Resistance CB2-EV75		● Yellow		
Resistance CB2-EV76		● Blue		
	Flush button with lamp Directness 6V~380V	CB2-EW3161	N/O	○ White
		CB2-EW3361	N/O	● Green
		CB2-EW3462	N/C	● Red
		CB2-EW3561	N/O	● Yellow
		CB2-EW3661	N/O	● Blue
		CB2-EW3365	N/O+N/C	● Green
		CB2-EW3465	N/O+N/C	● Red
	For making up body assemblies with 3, 4,5 or maximum of 6 contact blocks or replacing 1 st or and contact	CB2-EZ101	N/O	● Green
		CB2-EZ103	N/O+N/O	● Green
		CB2-EZ105	N/O+N/C	● Green ● Red
		CB2-EZ102	N/C	● Red
		CB2-EZ104	N/C+N/C	● Red ● Red

Metal Type	Description	Type	Scheme	color
	Flush button spring return	CB2-BA11	N/O	○ White
		CB2-BA21	N/O	● Black
		CB2-BA31	N/O	● Green
		CB2-BA51	N/O	● Yellow
		CB2-BA61	N/O	● Blue
		CB2-BA42	N/C	● Red
		CB2-BA25	N/O+N/C	● Black
		CB2-BA35	N/O+N/C	● Green
		CB2-BA45	N/O+N/C	● Red
	Button with protective cover IP65	CB2-BP11	N/O	○ White
		CB2-BP21	N/O	● Black
		CB2-BP31	N/O	● Green
		CB2-BP51	N/O	● Yellow
		CB2-BP61	N/O	● Blue
		CB2-BP42	N/C	● Red
		CB2-BP25	N/O+N/C	● Black
		CB2-BP35	N/O+N/C	● Green
		CB2-BP45	N/O+N/C	● Red
	Protruding button	CB2-BL11	N/O	○ White
		CB2-BL21	N/O	● Black
		CB2-BLP31	N/O	● Green
		CB2-BL51	N/O	● Yellow
		CB2-BL61	N/O	● Blue
		CB2-BL42	N/C	● Red
		CB2-BL25	N/O+N/C	● Black
		CB2-BL35	N/O+N/C	● Green
		CB2-BL45	N/O+N/C	● Red
	Standard handle knob	CB2-BD21	N/O	∨
		CB2-BD25	N/O+N/C	∨
		CB2-BD41	N/O	∨
		CB2-BD45	N/O+N/C	∨
		CB2-BD33	2NO	∨
		CB2-BD53	2NO	∨
	long handle knob	CB2-BJ21	N/O	∨
		CB2-BJ25	N/O+N/C	∨
		CB2-BJ41	N/O	∨
		CB2-BJ45	N/O+N/C	∨
		CB2-BJ33	2NO	∨
		CB2-BJ53	2NO	∨

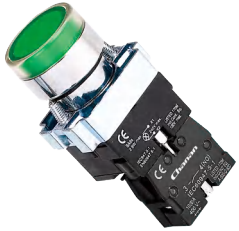
Metal Type	Description	Type	Scheme	color
	Key button	CB2-BG21	N/O	↘
		CB2-BG25	N/O+N/C	↘
		CB2-BG41	N/O	↘ ↗
		CB2-BG45	N/O+N/C	↘ ↗
		CB2-BG61	N/O	↘ ↗
		CB2-BG65	N/O+N/C	↘ ↗
		CB2-BG03	2NO	↕ ↗
		CB2-BG33	2NO	↕ ↗
		CB2-BG53	2NO	↕ ↗
		CB2-BG73	2NO	↕ ↗
	Double head button	CB2-BL8325	N/O+N/C	<div style="display: flex; gap: 5px;"> Green Red </div>
		CB2-BL8425	N/O+N/C	<div style="display: flex; gap: 5px;"> Green Red </div>
	Double head button with lamp 6V~380V	CB2-BW8365 (Directness)	N/O+N/C	<div style="display: flex; gap: 5px;"> Green Yellow Red </div>
		CB2-BW8465 (Directness)	N/O+N/O	<div style="display: flex; gap: 5px;"> Green Yellow Red </div>
		CB2-BW8375 (Resistance)	N/O+N/C	<div style="display: flex; gap: 5px;"> Green Yellow Red </div>
		CB2-BW8475 (Resistance)	N/O+N/C	<div style="display: flex; gap: 5px;"> Green Yellow Red </div>
	Mushroom button spring return	φ 40 CB2-BC21	N/O	● Black
		φ 40 CB2-BC31	N/O	● Green
		φ 40 CB2-BC42	N/C	● Red
		φ 40 CB2-BC51	N/O	● Yellow
		φ 60 CB2-BR21	N/O	● Black
		φ 60 CB2-BR31	N/O	● Green
		φ 60 CB2-BR42	N/C	● Red
		φ 60 CB2-BR52	N/O	● Yellow
	Mushroom rotation auto-reset emergency button	φ 30 CB2-BS442	N/C	● Red
		φ 40 CB2-BS542	N/C	● Red
		φ 60 CB2-BS642	N/C	● Red

Metal Type	Description	Type	Scheme	color
	Push and pull type emergency button	φ 40 CB2-BT42	N/C	● Red
		φ 40 CB2-BT845	N/O+N/C	● Red
	Mushroom rotation auto-reset emergency button with key	φ 40 CB2-BS142	N/C	● Red
		φ 40 CB2-BS8445	N/O+N/C	● Red
	Indicator light 6V~380V	Directness CB2-BV61		○ White
		Directness CB2-BV63		● Green
		Directness CB2-BV64		● Red
		Directness CB2-BV65		● Yellow
		Directness CB2-BV66		● Blue
		Resistance CB2-BV71		○ White
		Resistance CB2-BV73		● Green
		Resistance CB2-BV74		● Red
Resistance CB2-BV75		● Yellow		
Resistance CB2-BV76		● Blue		
	Flush button with lamp Directness 6V~380V	CB2-BW3161	N/O	○ White
		CB2-BW3361	N/O	● Green
		CB2-BW3462	N/C	● Red
		CB2-BW3561	N/O	● Yellow
		CB2-BW3661	N/O	● Blue
		CB2-BW3365	N/O+N/C	● Green
		CB2-BW3465	N/O+N/C	● Red
	2-Position Knob lamp 6V~380V	CB2-BK2365	N/O+N/C	● Green
		CB2-BK2465	N/O+N/C	● Red
	3-Position Knob lamp 6V~380V	CB2-BK3365	N/O+N/C	● Green
		CB2-BK3465	N/O+N/C	● Red

Metal Type	Description	Type	Scheme	color
	For making up body assemblies with 3, 4,5 or maximum of 6 contact blocks or replacing 1 st or and contact	CB2-BZ101	N/O	● Green
		CB2-BZ103	N/O+N/O	● Green
		CB2-BZ105	N/O+N/C	● Green ● Red
		CB2-BZ102	N/C	● Red
		CB2-BZ104	N/C+N/C	● Red
				● Red
	Bottombase seat of button with lamp Direct Type Neon(BA9S) LED	CB2-BV6	Without bracket	
		CB2-BW06	With bracket	
	Bracket	CB2-BZ009	Bracket	
	For making up body assemblies with 3, 4,5 or maximum of 6 contact blocks or replacing 1 st or and contact	CB2-BE102	N/C	● Red
	For making up body assemblies with 3, 4,5 or maximum of 6 contact blocks or replacing 1 st or and contact	CB2-BE101	N/O	● Green



Pushbutton Switch (φ22mm)

Standard_ IEC60947-5-1

Metal Type	Description	Type	Scheme	color	Qty/Ctn
	Flush button spring return	CB4-BA11	N/O	 White	200
		CB4-BA21	N/O	 Black	
		CB4-BA31	N/O	 Green	
		CB4-BA51	N/O	 Yellow	
		CB4-BA61	N/O	 Blue	
		CB4-BA42	N/C	 Red	
		CB4-BA25	N/O+N/C	 Black	
		CB4-BA35	N/O+N/C	 Green	
CB4-BA45	N/O+N/C	 Red			
	Button with protective cover IP65	CB4-BP11	N/O	 White	200
		CB4-BP21	N/O	 Black	
		CB4-BP31	N/O	 Green	
		CB4-BP51	N/O	 Yellow	
		CB4-BP61	N/O	 Blue	
		CB4-BP42	N/C	 Red	
		CB4-BP25	N/O+N/C	 Black	
		CB4-BP35	N/O+N/C	 Green	
CB4-BP45	N/O+N/C	 Red			
	Protruding button	CB4-BL11	N/O	 White	200
		CB4-BL21	N/O	 Black	
		CB4-BL31	N/O	 Green	
		CB4-BL51	N/O	 Yellow	
		CB4-BL61	N/O	 Blue	
		CB4-BL42	N/C	 Red	
		CB4-BL25	N/O+N/C	 Black	
		CB4-BL35	N/O+N/C	 Green	
CB4-BL45	N/O+N/C	 Red			
	Standard handle knob	CB4-BD21	N/O		200
		CB4-BD25	N/O+N/C		
		CB4-BD41	N/O		
		CB4-BD45	N/O+N/C		
		CB4-BD33	2NO		
CB4-BD53	2NO				
	long handle knob	CB4-BJ21	N/O		200
		CB4-BJ25	N/O+N/C		
		CB4-BJ41	N/O		
		CB4-BJ45	N/O+N/C		
		CB4-BJ33	2NO		
CB4-BJ53	2NO				

Metal Type	Description	Type	Scheme	color	Qty/Ctn
	Key button	CB4-BG21	N/O		200
		CB4-BG25	N/O+N/C		
		CB4-BG41	N/O		
		CB4-BG45	N/O+N/C		
		CB4-BG61	N/O		
		CB4-BG65	N/O+N/C		
		CB4-BG03	2NO		
		CB4-BG33	2NO		
	Indicator light 6V~380V	Directness CB4-BV61		 White	200
		Directness CB4-BV63		 Green	
		Directness CB4-BV64		 Red	
		Directness CB4-BV65		 Yellow	
		Directness CB4-BV66		 Blue	
	Flush button with lamp 6V~380V	CB4-BW3161	N/O	 White	200
		CB4-BW3361	N/O	 Green	
		CB4-BW3462	N/C	 Red	
		CB4-BW3561	N/O	 Yellow	
		CB4-BW3661	N/O	 Blue	
		CB4-BW3165	N/O+N/C	 White	
		CB4-BW3365	N/O+N/C	 Green	
		CB4-BW3465	N/O+N/C	 Red	
		CB4-BW3565	N/O+N/C	 Yellow	
		CB4-BW3665	N/O+N/C	 Blue	
	Double head button	CB4-BL8325	N/O+N/C	 Green	200
		CB4-BL8425		 Red	
	Double head button with lamp 6V~380V	CB4-BW8365 (Directness)	N/O+N/C	 Green	200
		CB4-BW8465 (Directness)		 Yellow  Red	
				 Green  Yellow  Red	

Metal Type	Description	Type	Scheme	color	Qty/Ctn
	Mushroom button spring return	\$40 CB4-BC21	N/O	● Black	200
		\$40 CB4-BC31	N/O	● Green	
		\$40 CB4-BC42	N/C	● Red	
		\$40 CB4-BC51	N/O	● Yellow	
		\$60 CB4-BR21	N/O	● Black	100
		\$60 CB4-BR31	N/O	● Green	
		\$60 CB4-BR42	N/C	● Red	
		\$60 CB4-BR51	N/O	● Yellow	
	Mushroom rotation auto-reset emergency button	\$30 CB4-BS442	N/C	● Red	200
		\$40 CB4-BS542	N/C	● Red	100
		\$60 CB4-BS642	N/C	● Red	
	Push and pull type emergency button	\$40 CB4-BT42	N/C	● Red	200
		\$40 CB4-BT45	N/O+N/C	● Red	
	Mushroom rotation auto-reset emergency button with key	\$40 CB4-BS142	N/C	● Red	200
		\$40 CB4-BS8445	N/O+N/C	● Red	
	illuminated 2-position stay put LED 6V~380V	CB4-BK2365	NO+NC	● Green	200
		CB4-BK2465	NO+NC	● Red	
	illuminated 3-position stay put LED 6V~380V	CB4-BK3365	NO+NC	● Green	
		CB4-BK3365	NO+NC	● Red	

Metal Type	Description	Type	color	Qty/Ctn	
	For making up body assemblies with 3, 4, 5 or maximum of 6 contact blocks or replacing 1 st or 2nd contact	CB4-BZ101	N/O	● Green	500
		CB4-BZ103	N/O+N/O	● Green ● Green	
		CB4-BZ105	N/O+N/C	● Green ● Red	
		CB4-BZ102	N/C	● Red	
		CB4-BZ104	N/C+N/C	● Red ● Red	
	Bottom base seat of button with lamp Direct Type Neon(BA9S) LED	CB4-BV6	Without bracket	500	
		CB4-BW06	With bracket		
	Bracket	CB4-BZ009	Bracket	1000	
	For making up body assemblies with 3, 4, 5 or maximum of 6 contact blocks or replacing 1 st or 2nd contact	CB4-BE102	N/C	● Red	1400
	For making up body assemblies with 3, 4, 5 or maximum of 6 contact blocks or replacing 1 st or 2nd contact	CB4-BE101	N/O	● Green	1400































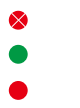





Control Box

Standard_ IEC60947-5-1

Plastic Type	Description	Type	Scheme	Marking on legend	Marking push button	
	1 green flush pushbutton spring return	CAL-B101H29	N/O	Start	●	
		CAL-B102		—	ⓘ	
		CAL-B103		—	—	●
		CAL-B101		—	—	●
	1 red protecting pushbutton spring return marked	CAL-B112	N/C	—	⓪	
	1 Selector switch 2-positions stay put Standard black handle	CAL-B132H29	N/O	Start Stop	⊕	
		CAL-B134H29	N/O	— ○	⊕	
	1 red mushroom head button, φ 40mm, latching Turn to release	CAL-J174	N/C	—	●	
		CAL-J174H29		Emergency Stop	●	
	1 red mushroom head button, φ 40mm, latching Turn to release cover with lock	CAL-P174	N/C	— Emergency Stop	● ●	
	1 red mushroom head button, φ 40mm, latching Key release (Key n° 445) IP40/65	CAL-J184	N/C	—	●	
		CAL-J184H29		Emergency Stop	●	

Control Box

Standard_ IEC60947-5-1

Plastic Type	Description	Type	Scheme	Marking on legend	Marking push button	
	2 spring return push button 1 flush green 1 flush red	CAL-B211H29	N/O 	Stop Start		
		CAL-B213	+	—	—	
		CAL-B215	N/C		—	
	2 spring return pushbutton 1 flush white (black arrow) 1 flush black (white arrow)	CAL-B222	N/O 	—		
		CAL-B223	N/C		—	
	2 spring return push button 2 flush green 1 flush red	CAL-B361H29	N/O  + N/C  + N/O 	Start Stop Start	  	
	1 red pilot light, Directly supply $\leq 130\star$ Buld not supplied+ 2 spring return pushbuttons 1 flush green 1 flush red	CAL-B363	LED  +	—		
		CAL-B363H29	N/C  +	N/O 	Start Stop	
	3 spring return pushbutton 1 flush white (black arrow) 1 flush red 1 flush black (white arrow)	CAL-B324	N/O 	—		
		CAL-B334	N/C  +	N/O 	—	
	2 spring return pushbutton + 1 Mushroom button	CAL-B339	N/O 	—		
CAL-B393	N/C  +	N/O 	—			

Rotary Switch



LW26-10



LW26-20



LW26-25



LW26-32



LW26-63



LW26-125

Introduction

The LW26 series rotary switch mainly applies to 440V and below, AC 50Hz or 240V and below DC circuits. For breaking and closing, change-over of circuits under unfrequently manual operation. And the typical application are: control switch of 3 phase motors, control switch of switch gear, control switch of instruments, and change-over switch of machinery and welding machine.

- The series comply with the IEC 60947-3, IEC 60947-5-1.
- The LW26 series have 8 current ratings: 10A, 20A, 25A, 32A, 63A, 125A, 160A and 315A.
- The LW26 series rotary switch were designed for multiple functions, wide variety of applications.
- The LW26-10, LW26-20, LW26-25, and LW26-32F have finger protection terminals.
- Both of them are applicable in circuits when an physical control is required.
- We can equip protective box for 20A, 25A, 32A and 63A.

Working conditions

- Ambient temperature do not exceed 40°C, and the average temperature, measured over a period of 24 hours, do not exceed 35°C.
- Ambient temperature should not be below -25°C.
- Should Not be installed over 2000m above sea level.
- The humidity should not exceed 50% when the ambient temperature is 40°C and higher humidity is allowed for lower temperature.

Installation conditions

- A clean environments is required.
- Please follow our manual

Designation

Use as control switches

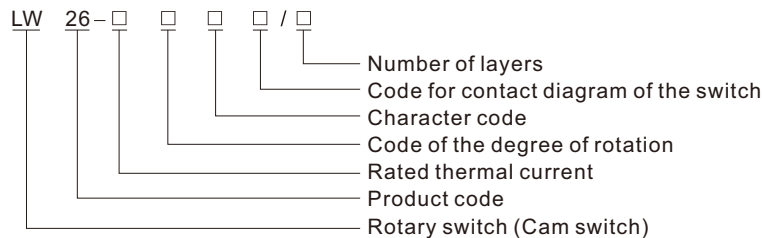

Re: Character code represent the rotating type, for instance, we have limited movement, spring return and limited movement with spring return. Code of the degree of rotation: 30°(3); 45°(4); 60°(6); 90°(9). 30°spring return, 60°limited movement(36); 30°spring return, 90°limited movement(39).

Use as motor switches

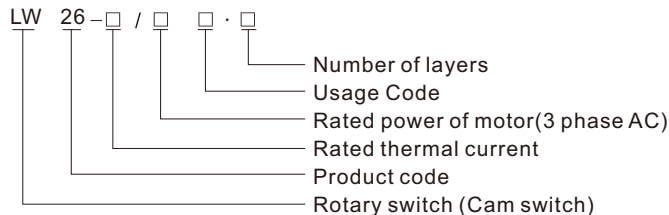

Re1: usage code (1) Q for start and run (2) N for start and reversing (3) S start and run at 2 speed (4) SN for start and reversing of 2 speed motor (5) M16 for start and reversing of 3 speed motor
 Re2: switches in this category normally rotated at 60° or 90°. And the SN normally rotated at 45°.

Use as control switch for a main circuit

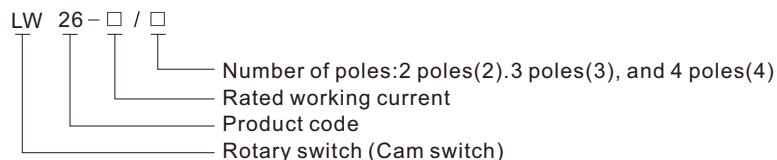

Re: switches in this category normally rotated at 60° or 90°

Rotary Switch



LW26-160



LW26-315

Classification

1. Classified by utilization

- Change-over switch;
- Motor switch;
- Control switch.

2. Classified by operation

- Limited movement;
- Spring return;
- Limited movement with spring return.

3. Classified by contact system

- Switches with limited movement could have 12 layers in maximum (for 32 A and below). And for 63 A and above could have 8 layers in maximum;
- Switches with spring return could have 3 layers in maximum;
- Motor switches could have 6 layers in maximum.

4. Diagram for the operation and position of handle

Operation angle	Character code	Position of handle			
		30° Rotation	45° Rotation	60° Rotation	90° Rotation
Spring return	A	0° ←30°	0° ←45°	0° ←60°	0° ←90°
	B	30° →0° ←30°	45° →0° ←45°	60° →0° ←60°	90° →0° ←90°
	X	60° →30° →0° ←30° ←60°	90° →45° →0° ←45° ←90°		
	Y	90° →60° →30° →0° ←30° ←60° ←90°			
Limited movement	C	0° 30°	0° 45°	0° 60°	
	D	30° 0° 30°	45° 0° 45°	60° 0° 60°	
	E	30° 0° 30° 60°	45° 0° 45° 90°	60° 0° 60° 120°	
	F	60° 30° 0° 30° 60°	90° 45° 0° 45° 90°	60° 0° 60° 120° 180°	
	G	60° 30° 0° 30° 60° 90°	90° 45° 0° 45° 90° 135°	120° 60° 0° 60° 120° 180°	
	H	90° 60° 30° 0° 30° 60° 90°	135° 90° 45° 0° 45° 90° 135°		
	I	90° 60° 30° 0° 30° 60° 90° 120°	135° 90° 45° 0° 45° 90° 135° 180°		
	J	120° 90° 60° 30° 0° 30° 60° 90° 120°			
	K	120° 90° 60° 30° 0° 30° 60° 90° 120° 150°			
	L	150° 120° 90° 60° 30° 0° 30° 60° 90° 120° 150°			
	M	150° 120° 90° 60° 30° 0° 30° 60° 90° 120° 150° 180°			
	N		45° 45°	30° 30°	
	P				90° 0° 90°
	T				0° 90°
V				90° 0°	
R				270° 0° 90° 180°	
Limited movement with spring return	Q	30° 0° ←30°	45° 0° ←45°		
	S	30° →0° 60°	90° 0° ←45°		
	W		90° →45° 0° 45° ←90°		
	Z	120° →90° 0° ←30°	135° →90° 0° ←45°		

Rotary Switch

Escutcheon plate and Handle

Escutcheon plate

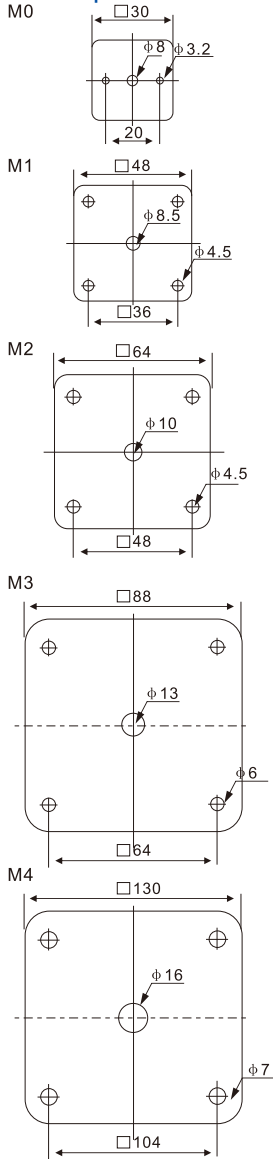

Type of handle

Type of handle	Color	Escutcheon plate					Type of handle	Color	Escutcheon plate				
		M0	M1	M2	M3	M4			M0	M1	M2	M3	M4
R Type 	Black Red White Gray Yellow	●	●	●			I Type 	Black Red White Gray Yellow	●	●	●	●	●
R2 Type 	Black Red White Gray	●	●				B Type 	Black Red White Gray	●	●	●	●	
F Type 	Black Red White Gray	●	●	●			L Type 	Black Red White Gray				●	
H Type 	Black Red White Gray		●				O Type 	Black Red White Gray				●	
P Type 	Black Red White Gray		●	●	●		K Type 	Black Red White Gray				●	●

Re: ● Standard, ● Optional

Description	Escutcheon plate						Type of handle										Rotating angle				Maximum Number of layers			
	M0	M1	M1B	M2	M2B	M3	R	R2	F	I	R	H	I	O	P	K	30°	45°	60°	90°	12	10	8	
LW26-10	●								●	●							●	●	●	●			●	
LW26-20	●	●	●	●	●		●	●	●	●	●	●	●	●	●	●	●	●	●	●			●	
LW26-25	●	●	●	●			●	●	●	●	●	●	●	●	●	●	●	●	●	●			●	
LW26-32				●	●	●	●	●	●	●	●	●	●	●	●	●	●	●	●	●			●	
LW26-63				●	●	●	●	●	●	●	●	●	●	●	●	●	●	●	●	●			●	
LW26-125						●	●								●	●	●	●	●				●	
LW26-160						●	●								●	●	●	●	●				●	
LW26-315									●						●									

Re: M1B M2B Plate should be installed by self tapping screw.

Rotary Switch

Dimensions and installation Square escutcheon plate and rectangular escutcheon plate

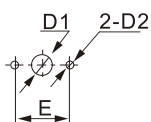
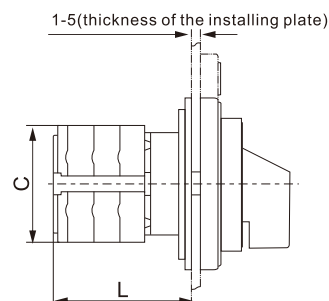
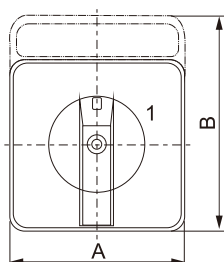

LW26-10 Installation

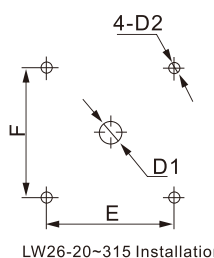

LW26-20~315 Installation

Description	Escutcheon plate	Dimensions (mm)				Installation (mm)			
		A	B	C	L	E	F	D1	D2
LW26-10	M0 square	30	30	28	22+8n	20		φ 8	φ 3.2
LW26-20	M1 square	48	48	43	22+9.6n	36	36	φ 8.5	φ 4.5
	M1 rectangular	48	60	43	22+9.6n	36	36	φ 8.5	φ 4.5
	M2 square	64	64	43	25+9.6n	48	48	φ 10	φ 4.5
	M2 rectangular	64	80	43	25+9.6n	48	48	φ 10	φ 4.5
LW26-25	M1 square	48	48	45.2	23+12.8n	36	36	φ 8.5	φ 4.5
	M1 rectangular	48	60	45.2	23+12.8n	36	36	φ 8.5	φ 4.5
	M2 square	64	64	45.2	26.5+12.8n	48	48	φ 10	φ 4.5
	M2 rectangular	64	80	45.2	26.5+12.8n	48	48	φ 10	φ 4.5
LW26-32	M2 square	64	64	58	29.2+12.8n	48	48	φ 10	φ 4.5
	M2 rectangular	64	80	58	29.2+12.8n	48	48	φ 10	φ 4.5
	M3 square	88	88	58	29.2+12.8n	68	68	φ 13	φ 6
LW26-63	M2 square	64	64	66	29.2+21.5n	48	48	φ 10	φ 4.5
	M2 rectangular	64	80	66	29.2+21.5n	48	48	φ 10	φ 4.5
	M3 square	88	88	66	29.2+21.5n	68	68	φ 13	φ 6
LW26-125	M3 square	88	88	84	35+26.5n	68	68	φ 13	φ 6
LW25-160	M3 square	88	88	88	35+32.5n	68	68	φ 13	φ 6
LW25-315	M4 square	130	130	126	39.5+38.5n	104	104	φ 16	φ 7

Re: n for number of layers.

Rotary Switch

Technical parameters

Description	LW26-10	LW26-20	LW26-25	LW26-32	LW26-63	LW26-125	LW26-160	LW26-315
Rated insulation voltage U_i V	660	660	660	660	660	660	660	660
Rated thermal current I_{th} A	10	20	25	32	63	125	160	315
Rated working voltage U_e V	240 440	240 440	240 440	240 440	240 440	240 440	240 440	240 440
Rated working current I_e								
AC-21A AC-22A	A 10 10	20 20	25 25	32 32	63 63	100 100	150 150	315 315
AC-23A	A 7.5 7.5	15 15	22 22	30 30	57 57	90 90	135 135	265 265
AC-2	A 7.5 7.5	15 15	22 22	30 30	57 57	90 90	135 135	265 265
AC-3	A 5.5 5.5	11 11	15 15	22 22	36 36	75 75	95 95	110 110
AC-4	A 1.75 1.75	3.5 3.5	6.5 6.5	11 11	15 15	30 30	55 55	95 95
AC-15	A 2.5 1.5	5 4	8 5	14 6				
AC-13	A	0.4	0.5					
Power P								
AC-23A	KW 1.8 3	3.7/2.5 7.5/3.7	5.5/3 11/5.5	7.5/4 15/7.5	15/10 30/18.5	30/15 45/22	37/22 75/37	75/37 132/55
AC-2	KW 2.5 3.7	4 7.5	5.5 11	7.5 15	18.5 30	30 45	37 55	55 95
AC-3	KW 1.5 2.2	3/2.2 5.5/3	4/3 7.5/3.7	5.5/4 11/5.5	11/6 18.5/11	15/7.5 30/13	22/11 37/18.5	37/22 55/30
AC-4	KW 0.37 0.55	0.55/0.75 1.5/1.5	1.5/1.1 3/2.2	2.7/1.5 5.5/3	5.5/2.4 7.5/4	6/3 12/5.5	10/4 15/7.5	15/7.5 25/11

Re1:Neutral;

Re2:The power under :AC-23A、AC-3、AC-4 are in three phase three pole, and the denominator represents the power under single phase two poles.

Mechanical life

Mechanical life without load : 0.1×10^6 times , operation frequency is 120 times/h.

Mechanical life with load : 0.03×10^6 times, operation frequency is 120 times/h.

Rotary Switch

General Panel Diagram

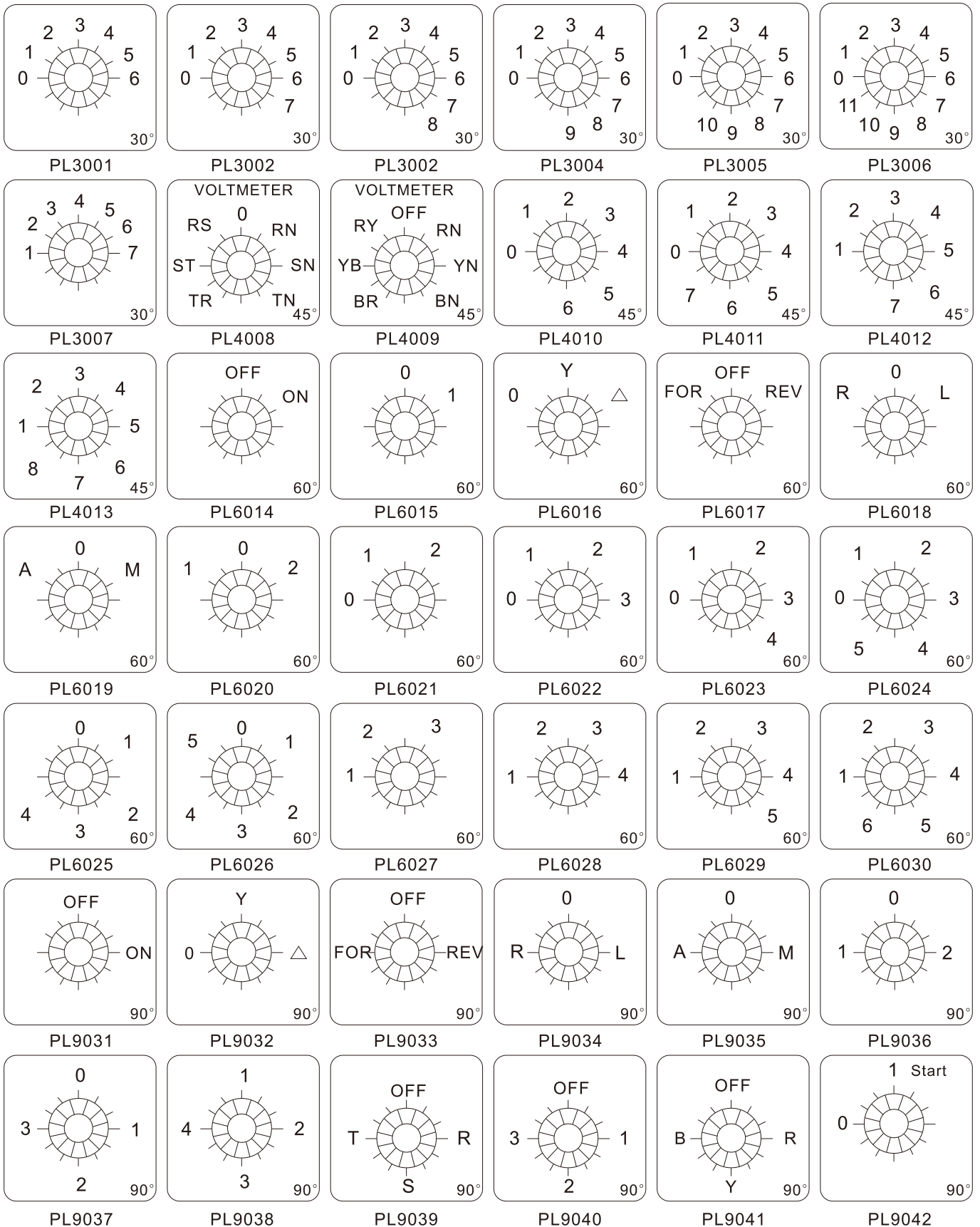

Rotary Switch

General Panel Diagram

<p>01</p>	<p>02</p>	<p>03</p>	<p>04</p>
<p>101</p>	<p>202</p>	<p>303</p>	<p>404</p>
<p>0111</p>	<p>01111</p>	<p>22</p>	<p>023</p>
<p>N</p>	<p>M07</p>	<p>S1</p>	<p>S2</p>
<p>LH3</p>	<p>YH5</p>	<p>YH2</p>	<p>M6886</p>

Isolation Switch

Introduction

- LW 30 series Isolation switches applied to circuits of AC 50Hz with working voltage up to 440V and rated working current up to 100A.
- LW 30 is suitable to control :air-conditioner, water pump and ventilating equipments, and AC Motors with small power.
- LW 30 series rotary switches have 7 current ratings: 20A,25A,32A,40A,63A,80A,and 100A.
- LW 30 series has the finger protection terminals, which offers an extra advantage.
- LW 30series switches has larger insulation distance, quick disconnecting response . And is a good choice For DC circuits, LW 30 has additional contact which enable us to install the contact separately
- LW 30 series rotary switches comply with :IEC60947-3.



LW30-20、25、32

Working conditions

- Ambient temperature Do Not exceed 40°C , and the average temperature, measured over a period of 24 hours , Do Not exceed 35°C
- Ambient temperature should not be below -25°C.
- Should Not be installed over 2000m above sea level .
- The humidity should not exceed 50% when the ambient temperature is 40°C and higher humidity is allowed for lower temperature.



LW30-40、63

Installation conditions

- A clean environment is required.
- Please follow our manual.

Classification

- .classified by utilization
 - (1)AC-23A
 - (2)AC-3
- .Classified by protective level
 - (1)Without plastic box :Ip20
 - (2)With plastic box :IP65

Designation



LW30-80、100

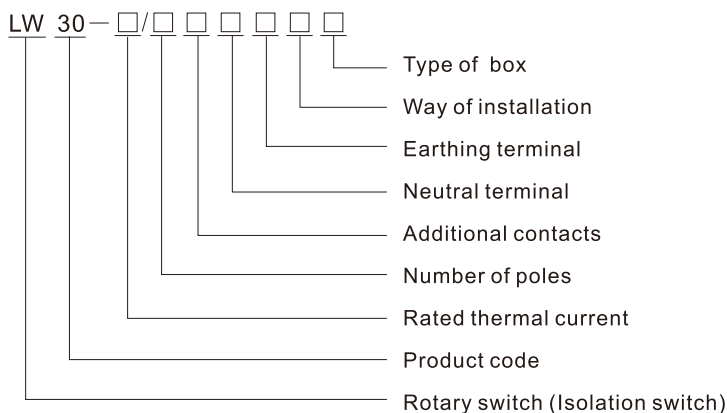

Isolation Switch

Accessorial code:

Number of poles :3P,4P

Additional contacts :0 for additional contacts not inclosed , 1 for with additional contacts

Neutral terminal:0 for neutral terminal not inclosed, 1 for with neutral terminal

Earthing terminal: 0 for earthing terminal not inclosed , 1 for with earthing terminal.

Installation:

1. Pad-lock escutcheon plate
 2. Escutcheon plate
 3. Single lock parallel installation
 4. Doorlock safety switch with padlock system
 5. Single hold installation
- Type of box :0 without protective box , 1 with IP65 Plastic box

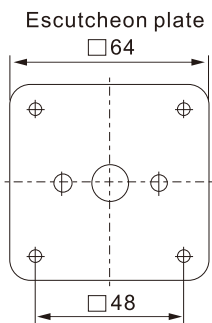

Accessories

Plastic box



Protective Cover



Auxiliary contact & Optional accessories



Earthing straight-through contacts



Aux. Contacts 1NO+1NC



2 cam additional contacts

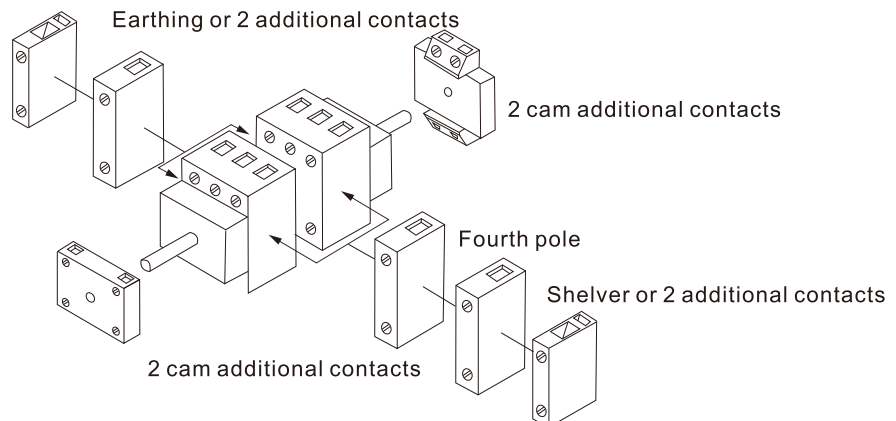

Isolation Switch

Technical parameters

Description	LW30-25(20)		LW30-32		LW30-40		LW30-63		LW30-80		LW30-100			
Rated thermal current I _{th} A	I _{th}	A	25(20)		32		40		63		80		100	
Rated working voltage U _e V	U _e	V	240	440	240	440	240	440	240	440	240	440	240	440
Rated value I _e /P _e	I _e /P _e													
AC-21A		A/KW	20/-	20/-	32/-	32/-	40/-	40/-	63/-	63/-	80/-	80/-	100/-	100/-
AC-22A		A/KW	20/-	20/-	32/-	32/-	40/-	40/-	63/-	63/-	80/-	80/-	100/-	100/-
AC-23A		A/KW	15/4	15/7.5	22/5.5	22/11	30/7.5	30/15	43/11	43/22	57/18.5	57/30	70/22	70/37
AC-3		A/KW	11.7/3	11.7/5.5	15/4	15/7.5	22/7.5	22/11	36/11	36/18.5	43/15	43/22	57/18.5	57/30

- Current type: 50Hz AC
- Number of main contact: ON and OFF
- Frequency :8 hours per day, 30 times per hour
- Mechanism Life:10000 times/ AC-23, 6000 times/AC-3,2000 times for additional contact.

Order Procedurer

When you order our LW 30 series, We need your data as following

1. Rated working current, for example :LW 30-20;
2. Accessorial code , please write it orderly
 - (1) Number of poles , for example:3P;
 - (2) Do you need additional contacts: 0 not inclosed, 1 inclosed
 - (3) Do you need neutral terminal: 0 not inclosed, 1 inclosed;
 - (4) Do you need earthing terminal: 0 not inclosed ,1 inclosed;
 - (5) Way of installation:
 - 1.Escutcheon plate with pad-lock
 - 2.Escutcheon plate
 - 3.Single lock parallel installation
 - 4.Doorlock safety switch with padlock system
 5. Single hole installation
 - (6) Type of box: 0 not inclosed, 1 inclosed.
3. Other accessorial code, please write it orderly
 - (1) Type of Escutcheon plate: 1 Escutcheon plate;
 - 2 Denote ϕ 22.5 hole;
 - 3 Denote ϕ 25 hole;
 - 4 Denote ϕ 30.5 hole.
 - (2) Do you need Escutcheon plate with airproof: 0 Not incloesd it , 1 incloesnr it
 - (3) Colour of bottom plate: 1 Denote silver color; 2 Denote yellow;
 - 3 Male it against your color
 - (4) Character letter: 1 denote letter; 2 Chinese letter ; 3 Special sign

For example:

If you order 40A/3P with additional contacts and earthing terminal Escutcheon plate without neutral terminal and plastic box. You must write: LW30-40/310120

If you want to order 32A/3 with Doorlock safety switch, You must write: LW30-32/300040.

If you want to order 40A/3 with adding contacts, earthing terminal, Escutcheon plate, plate with airproof , Yellow, Chinese letter, K handle; without neutral terminal and plastic box. You must write: LW30-40/310120.1123.

Isolation Switch

Dimensions and installation Panel installation

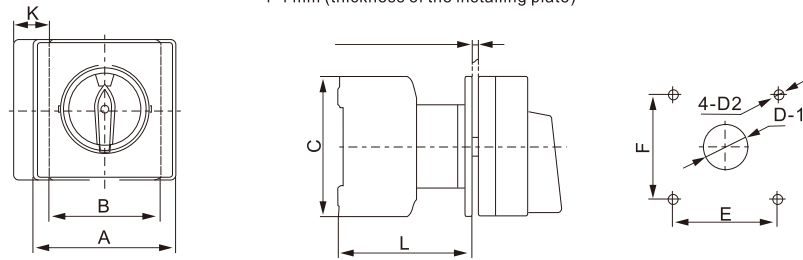

Description	Dimensions(mm)					Installation(mm)			
	A	B	C	K	L	E	F	D1	D2
LW30-20	□64	42	54	13.5	61	48	48	φ 10	φ 4.2
LW30-25	□64	42	54	13.5	61	48	48	φ 10	φ 4.2
LW30-32	□64	42	54	13.5	61	48	48	φ 10	φ 4.2
LW30-40	□64	50	64	16	67	48	48	φ 10	φ 4.2
LW30-63	□64	50	64	16	67	48	48	φ 10	φ 4.2
LW30-80	□64	70	80	22.5	82	48	48	φ 10	φ 4.2
LW30-100	□64	70	80	22.5	82	48	48	φ 10	φ 4.2

Installation of doorlock safety switch

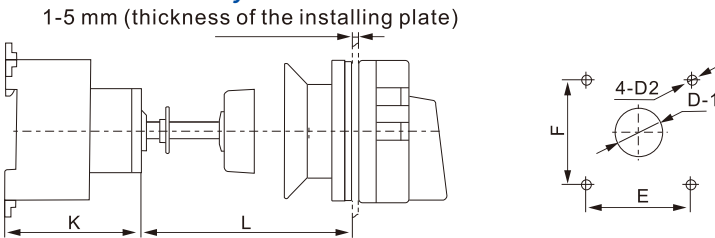
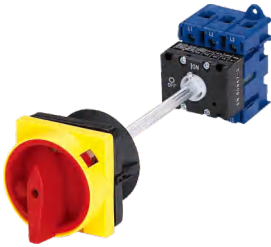

Description	Dimensions(mm)			Installation(mm)			
	K	L min	L max	E	F	D1	D2
LW30-20	50	32	150	48	48	φ 22	φ 4.2
LW30-25	50	32	150	48	48	φ 22	φ 4.2
LW30-32	50	32	150	48	48	φ 22	φ 4.2
LW30-40	61	32	150	48	48	φ 22	φ 4.2
LW30-63	61	32	150	48	48	φ 22	φ 4.2
LW30-80	68	32	150	48	48	φ 22	φ 4.2
LW30-100	68	32	150	48	48	φ 22	φ 4.2

Re:Product can be installed in 35 mm Din-rail.

Protective cover

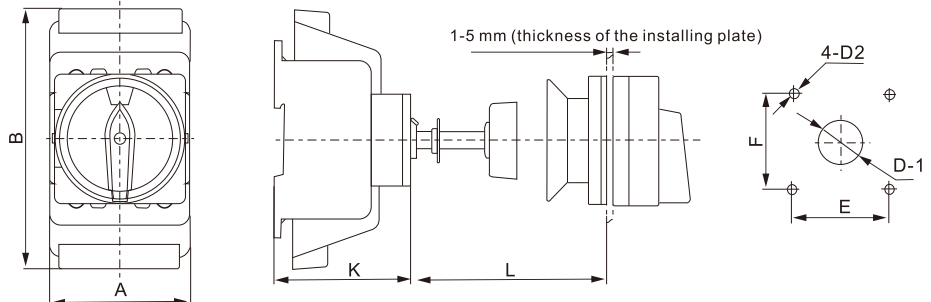

Description	Dimensions(mm)					Installation(mm)			
	A	B	K	Lmin	Lmax	E	F	D1	D2
LW30-80	70	133	68	32	150	48	48	φ 22	φ 4.2
LW30-100	70	133	68	32	150	48	48	φ 22	φ 4.2

Isolation Switch

Plastic box(IP65)



LW30-20
LW30-25
LW30-32

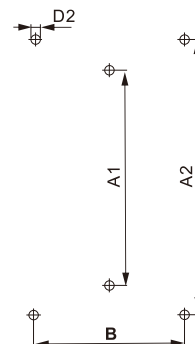
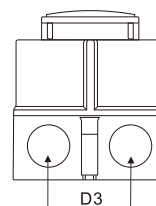
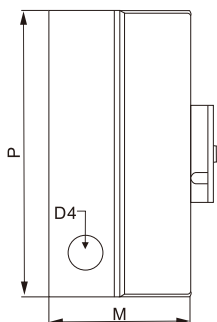
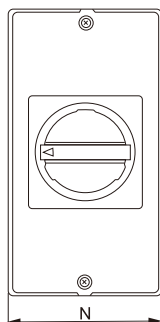

LW30-40
LW30-63

Description	Dimensions(mm)					Installation(mm)			
	D3	D4	M	N	P	A1	A2	B	D2
LW30-20	φ 23	φ 19	85	83	160	150	--	--	φ 4.2
LW30-25	φ 23	φ 19	85	83	160	150	--	--	φ 4.2
LW30-32	φ 23	φ 19	85	83	160	150	--	--	φ 4.2
LW30-40	φ 29	φ 23	100	95	190	178	--	--	φ 4.2
LW30-63	φ 29	φ 23	100	95	190	178	--	--	φ 4.2
LW30-80	φ 37.5	φ 23	144	105	250	--	229	124	φ 6.5
LW30-100	φ 37.5	φ 23	144	105	250	--	299	124	φ 6.5



LW30-80
LW30-100

Isolation Switch

PV DC TYPE

Designation

LW 30 - □ □ □ □ □ □ □ □

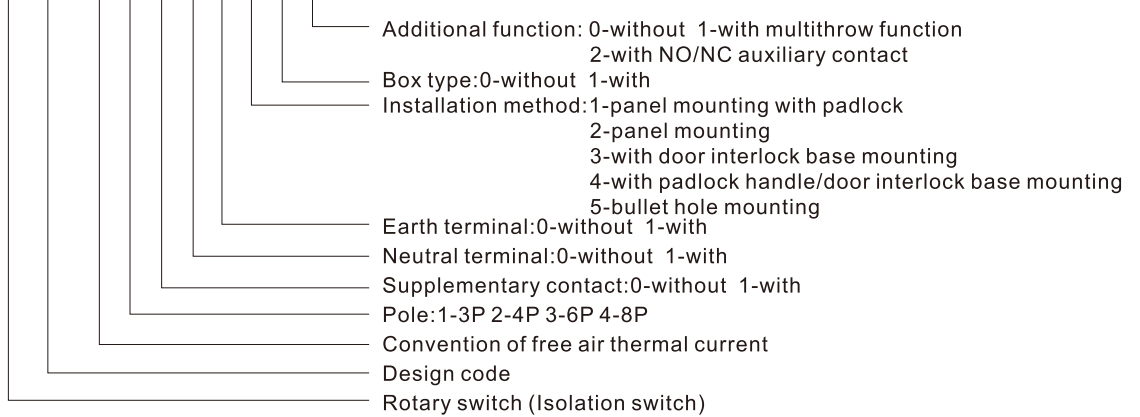

Stripping length

LW30-20
LW30-32

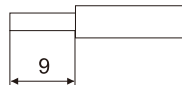

LW30-40



4pole DC

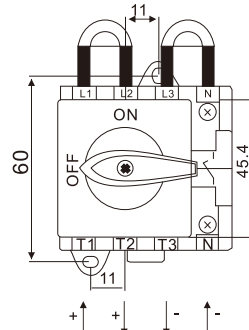
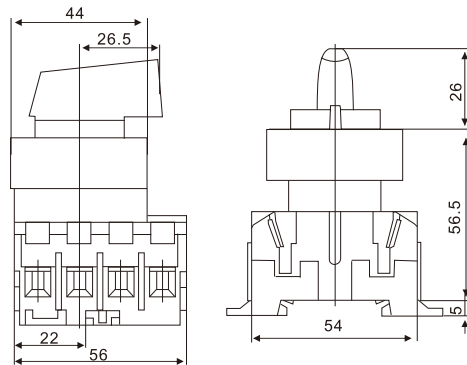

Connection diagram



Description	Working current	Working voltage (DC)	MAX PV load voltage(DC)	Insulation voltage	Connection wire diameter (mm)
LW30-20	16A	450V	520V	690V	∅ 2.5
LW30-32	25A	450V	520V	690V	∅ 4
LW30-40	32A	450V	520V	690V	∅ 4.5
LW30-20	12A	500V	575V	690V	∅ 2.5
LW30-32	20A	500V	575V	690V	∅ 4

Use category: DC-22A

6pole DC

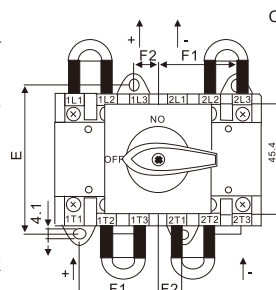
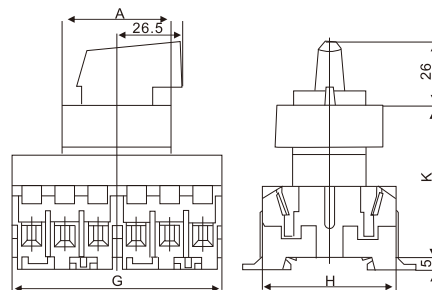

Connection diagram



Isolation Switch

Description	A	E	F1	F2	G	H	K
LW30-20/LW30-32	44	60	32	10	84	54	64
LW30-40	105.4	70	37.5	12.5	100	64	62.5

Description	Working current	Working voltage (DC)	MAX PV load voltage(DC)	Insulation voltage	Connection wire diameter (mm)
LW30-20	16A	650V	750V	1000V	∅ 2.5
LW30-32	32A	500V	575V	1000V	∅ 4
LW30-40	32A	650V	750V	1000V	∅ 4.5
LW30-20	12A	800V	920V	1000V	∅ 2.5
LW30-32	25A	650V	750V	1000V	∅ 4

Use category: DC-22A

PV DC TYPE 8pole DC

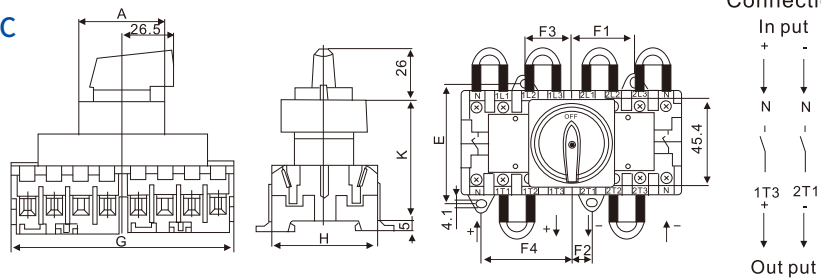

Connection diagram

Connection diagram

Description	A	E	F1	F2	F3	F4	G	H	K
LW30-20/LW30-32	44	60	32	10	24	46	111	54	64
LW30-40	105.4	70	37.5	12.5	28.5	53.5	132	64	62.5

Description	Working current	Working voltage (DC)	MAX PV load voltage(DC)	Insulation voltage	Connection wire diameter (mm)
LW30-20	16A	800V	920V	1000V	∅ 2.5
LW30-32	25A	800V	920V	1000V	∅ 4
LW30-40	32A	800V	920V	1000V	∅ 4.5

Use category: DC-22A

8pole DC

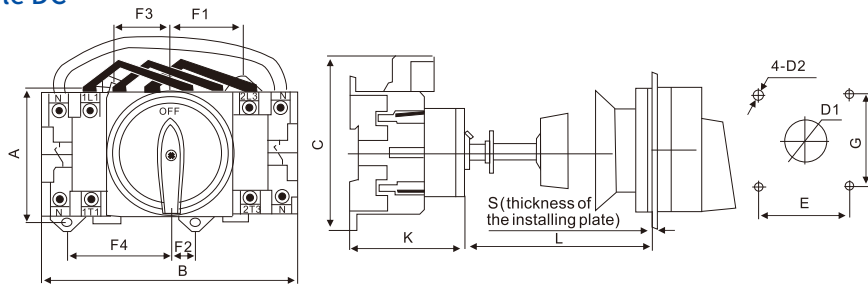
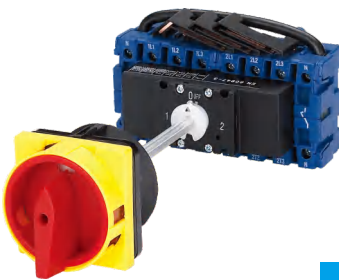

Description	Dimensions (mm)										Installation (mm)			
	A	B	C	K	F1	F2	F3	F4	L	S	E	G	D1	D2
LW30-20	60	111	78	50.5	32	10	24	46	32~150	1~5	48	48	∅ 22	∅ 4.5
LW30-25	60	111	78	50.5	32	10	24	46	32~150	1~5	48	48	∅ 22	∅ 4.5
LW30-32	60	111	78	50.5	32	10	24	46	32~150	1~5	48	48	∅ 22	∅ 4.5
LW30-40	70	132	90	61	37.5	12.5	28.5	53.5	32~150	1~5	48	48	∅ 22	∅ 4.5
LW30-63	70	132	90	61	37.5	12.5	28.5	53.5	32~150	1~5	48	48	∅ 22	∅ 4.5

Description	Working current	Working voltage (DC)	MAX PV load voltage(DC)	Insulation voltage	Connection wire diameter (mm)
LW30-20	16A	800V	920V	1000V	∅ 2.5
LW30-32	25A	800V	920V	1000V	∅ 4
LW30-40	32A	800V	920V	1000V	∅ 4.5

Use category: DC-22A

The logo consists of a solid blue square on the left. To its right, the word "Chanan" is written in a white, italicized, sans-serif font.

Chanan

CHANGAN GROUP CO.,LTD.

Add: No.288 Wei 17th Road,Economic Development Zone,
Yueqing City Zhejiang China.

Tel: 0086-577-62763666

Fax: 0086-577-62774090

E-mail:sales@changangroup.com.cn

Http://www.changangroup.com.cn